



# SPECIFICATION GUIDE

2024. V4

flexiform





## Contents

---

### office tables

- 006 additions tables
- 010 additions pedestal table
- 014 additions trumpet table
- 016 additions flip top tables
- 018 additions laptop table
- 020 additions 2 tables
- 028 parq
- 034 larke
- 038 channel work table
- 042 jot-up meet
- 044 x-range
- 046 hairpin

### office desks & screens

- 050 homeworker desks
- 052 todd desks
- 054 meira desks
- 058 pico desks
- 074 crank desks
- 076 a-up desks
- 078 jot-up desks
- 082 aero screens
- 084 sound acoustic panels
- 086 hoop

### office storage

- 092 contract pedestals
- 094 metro pedestals
- 096 metro storage
- 100 freestor hinged door
- 104 freestor side filer storage
- 106 freestor combi storage
- 110 freestor tambour storage
- 116 freestor accent lockers
- 120 metal lockers
- 124 luxo lockers
- 128 flora & fauna
- 130 storage top planters
- 132 recycling bins
- 134 credenza
- 136 wood credenza
- 138 flexilink
- 144 flexigrid

### office chairs

- 150 cote
- 154 equity chair
- 158 equity visitor chair
- 162 actualize chair
- 166 miss chairs
- 170 small valido lounge chair
- 172 valido lounge chair
- 174 papillon chair
- 178 olé chair
- 180 olé wood chair
- 182 cyla chair
- 184 flexi-work chair
- 186 tonez chair
- 188 melita chair
- 190 one-shot chair
- 192 college chair

### outdoor furniture

- 196 nuke in/out chair
- 198 decorative screens
- 200 flora & fauna

### finishes



office tables





# additions tables

## HOW TO SPECIFY ADDITIONS

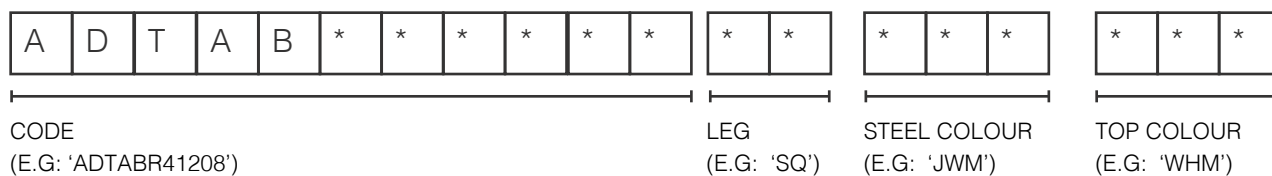

For example, to specify a 1200mm (w) x 800mm (d) x 740mm (h) all white additions table in square leg the code would be ADTABR41208SQJWMWHM. All tops are in MFC.

### Finishes

Black, Matt	BLM	Sapphire Blue, Matt	USM
Graphite Grey, Matt	GGM	Violet Blue, Matt	UVM
Jot Silver, Matt	JOM	Distant Blue, Matt	UDM
Pale Grey, Matt	PGM	Pastel Blue, Matt	UPM
White, Matt	JWM	Purple Red, Matt	RPM
Pale Brown, Matt	BPM	Red Violet, Matt	RYM
Grey Beige, Matt	BGM	Orient Red, Matt	ROM
Beige, Matt	BBM	Beige Red, Matt	RBM
Light Ivory, Matt	BIM	Tomato Red, Matt	RTM
Olive Green, Matt	GOM	Salmon Pink, Matt	PSM
Fern Green, Matt	GFM	Yellow Orange, Matt	OYM
Reed Green, Matt	GRM	Broom Yellow, Matt	YBM
Black Green, Matt	GBM		
Pine Green, Matt	GPM		
Patina Green, Matt	GAM		
Pale Green, Matt	GCM		

### Band 1 MFC Finishes

White	WHM
White/ Oak Edge	WHO
White/ Black Edge	WHB
Pale Grey	MOG
Dust Grey	DGM
Light Oak*	MOK*
Walnut*	MOW*

*\*Please note, we cannot guarantee continuity of these finishes.*

### Band 2 MFC Finishes

Cashmere Grey	MSC
Antique Rose	MAR
Reed Green	MRG
Denim Blue	MDB
Hamilton Oak	MHO
Nebraska Oak	MNO
Truffle Brown Oak	MDO
Natural Carini Walnut	MCW
Sevilla Ash	MSA
Chicago Concrete	MCC

### Leg Style

Round	RD
Square	SQ

# additions table /dining height table

## Rectangular Table with Round or Square Legs.

Table with 60mm diameter legs.

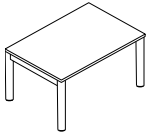

WIDTH



DEPTH



HEIGHT

ADTABR41006 ** ** **	1000mm	600mm	740mm
ADTABR41206 ** ** **	1200mm	600mm	740mm
ADTABR41406 ** ** **	1400mm	600mm	740mm
ADTABR41606 ** ** **	1600mm	600mm	740mm

ADTABR40808 ** ** **	800mm	800mm	740mm
ADTABR41008 ** ** **	1000mm	800mm	740mm
ADTABR41208 ** ** **	1200mm	800mm	740mm
ADTABR41408 ** ** **	1400mm	800mm	740mm
ADTABR41508 ** ** **	1500mm	800mm	740mm
ADTABR41608 ** ** **	1600mm	800mm	740mm
ADTABR41808 ** ** **	1800mm	800mm	740mm
ADTABR42008 ** ** **	2000mm	800mm	740mm
ADTABR42208 ** ** **	2200mm	800mm	740mm
ADTABR42408 ** ** **	2400mm	800mm	740mm

ADTABR41010 ** ** **	1000mm	1000mm	740mm
ADTABR41610 ** ** **	1600mm	1000mm	740mm
ADTABR41810 ** ** **	1800mm	1000mm	740mm
ADTABR42010 ** ** **	2000mm	1000mm	740mm
ADTABR42210 ** ** **	2200mm	1000mm	740mm
ADTABR42410 ** ** **	2400mm	1000mm	740mm

ADTABR41812 ** ** **	1800mm	1200mm	740mm
ADTABR42012 ** ** **	2000mm	1200mm	740mm
ADTABR42212 ** ** **	2200mm	1200mm	740mm
ADTABR42412 ** ** **	2400mm	1200mm	740mm

## Elliptical Table with Round or Square Legs.

Table with 60mm diameter legs.



WIDTH



DEPTH



HEIGHT

ADTABE41608 ** ** **	1600mm	800mm	740mm
ADTABE42010 ** ** **	2000mm	1000mm	740mm
ADTABE42412 ** ** **	2400mm	1200mm	740mm

## Double D Table with Round or Square Legs.

Table with 60mm diameter legs.

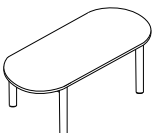

WIDTH



DEPTH



HEIGHT

ADTABD41608 ** ** **	1600mm	800mm	740mm
ADTABD42010 ** ** **	2000mm	1000mm	740mm
ADTABD42412 ** ** **	2400mm	1200mm	740mm

**Circular Table with Round or Square Legs.**

Table with 60mm diameter legs.

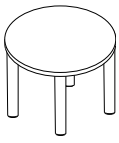

WIDTH



DEPTH



HEIGHT

ADTABC408 ** ** *	800mm	800mm	740mm
ADTABC409 ** ** *	900mm	900mm	740mm
ADTABC410 ** ** *	1000mm	1000mm	740mm
ADTABC412 ** ** *	1200mm	1200mm	740mm

## /coffee height table

**Rectangular Coffee Table with Round or Square Legs.**

Table with 60mm diameter legs.

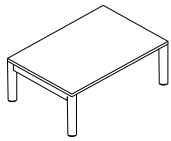

WIDTH



DEPTH



HEIGHT

ADTABLR0606 ** ** *	600mm	600mm	450mm
ADTABLR0806 ** ** *	800mm	600mm	450mm
ADTABLR1006 ** ** *	1000mm	600mm	450mm
ADTABLR1206 ** ** *	1200mm	600mm	450mm

**Circular Coffee Table with Round or Square Legs.**

Table with 60mm diameter legs.



WIDTH



DEPTH



HEIGHT

ADTABLC08 ** ** *	800mm	800mm	450mm
ADTABLC10 ** ** *	1000mm	1000mm	450mm







# additions pedestal table

## HOW TO SPECIFY A PEDESTAL BASE TABLE

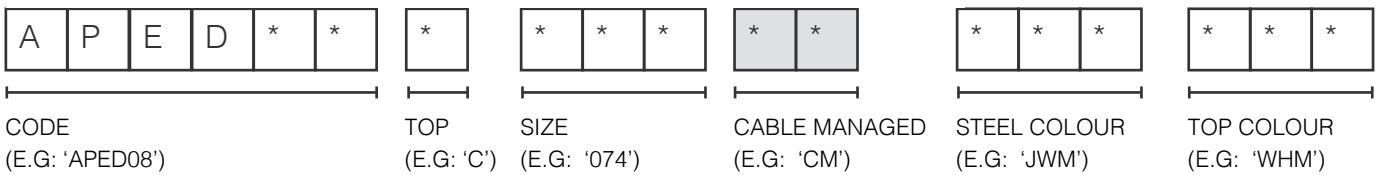

For example, to specify a circular 800mm (d) x 740mm (h) all white additions table the code would be APED08C074JWMWHM.  
All tops are in MFC.

### Finishes

Black, Matt	BLM	Sapphire Blue, Matt	USM
Graphite Grey, Matt	GGM	Violet Blue, Matt	UVM
Jot Silver, Matt	JOM	Distant Blue, Matt	UDM
Pale Grey, Matt	PGM	Pastel Blue, Matt	UPM
White, Matt	JWM	Purple Red, Matt	RPM
Pale Brown, Matt	BPM	Red Violet, Matt	RYM
Grey Beige, Matt	BGM	Orient Red, Matt	ROM
Beige, Matt	BBM	Beige Red, Matt	RBM
Light Ivory, Matt	BIM	Tomato Red, Matt	RTM
Olive Green, Matt	GOM	Salmon Pink, Matt	PSM
Fern Green, Matt	GFM	Yellow Orange, Matt	OYM
Reed Green, Matt	GRM	Broom Yellow, Matt	YBM
Black Green, Matt	GBM		
Pine Green, Matt	GPM		
Patina Green, Matt	GAM		
Pale Green, Matt	GCM		

### Band 1 MFC Finishes

White	WHM
White/ Oak Edge	WHO
White/ Black Edge	WHB
Pale Grey	MOG
Dust Grey	DGM
Light Oak*	MOK*
Walnut*	MOW*

*\*Please note, we cannot guarantee continuity of these finishes.*

### Band 2 MFC Finishes

Cashmere Grey	MSC
Antique Rose	MAR
Reed Green	MRG
Denim Blue	MDB
Hamilton Oak	MHO
Nebraska Oak	MNO
Truffle Brown Oak	MDO
Natural Carini Walnut	MCW
Sevilla Ash	MSA
Chicago Concrete	MCC

### Cable Management

With Cable Management CM

### Single Top Shape

Square	S
Circular	C

### Double Top Shape

Rectangular	R
Penisular	P
Double D End	D

# additions pedestal base tables /single base

## Circular Table with Flat Pedestal Base.

With or without cable management (CM).

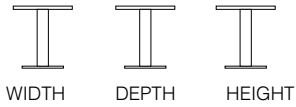
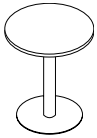

	WIDTH	DEPTH	HEIGHT
APED06C045 *** **	600mm	600mm	450mm
APED08C045 *** **	800mm	800mm	450mm
APED09C045 *** **	900mm	900mm	450mm
APED06C074 *** **	600mm	600mm	740mm
APED06C074CM *** **	600mm	600mm	740mm
APED08C074 *** **	800mm	800mm	740mm
APED08C074CM *** **	800mm	800mm	740mm
APED09C074 *** **	900mm	900mm	740mm
APED09C074CM *** **	900mm	900mm	740mm
APED10C074 *** **	1000mm	1000mm	740mm
APED10C074CM *** **	1000mm	1000mm	740mm
APED12C074 *** **	1200mm	1200mm	740mm
APED12C074CM *** **	1200mm	1200mm	740mm
APED06C105 *** **	600mm	600mm	1050mm
APED08C105 *** **	800mm	800mm	1050mm

## Square Table with Flat Pedestal Base.

With or without cable management (CM).

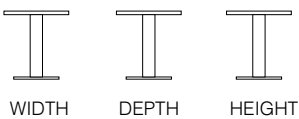
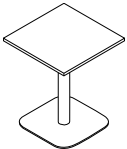

	WIDTH	DEPTH	HEIGHT
APED06S045 *** **	600mm	600mm	450mm
APED08S045 *** **	800mm	800mm	450mm
APED06S074 *** **	600mm	600mm	740mm
APED06S074CM *** **	600mm	600mm	740mm
APED08S074 *** **	800mm	800mm	740mm
APED08S074CM *** **	800mm	800mm	740mm
APED10S074 *** **	1000mm	1000mm	745mm
APED10S074CM *** **	1000mm	1000mm	745mm
APED06S105 *** **	600mm	600mm	1050mm
APED08S105 *** **	800mm	800mm	1050mm

# /double base

## Rectangular Double Pedestal Base Tables.

2x weighted 480mm square bases with 25mm thick top.

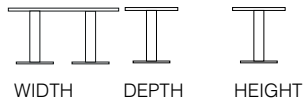
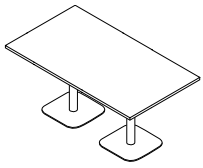

	WIDTH	DEPTH	HEIGHT
APED1608R074 *** **	1600mm	800mm	745mm
APED1809R074 *** **	1800mm	900mm	745mm
APED2010R074 *** **	2000mm	1000mm	745mm
APED1608R105 *** **	1600mm	800mm	1050mm
APED1809R105 *** **	1800mm	900mm	1050mm
APED2010R105 *** **	2000mm	1000mm	1050mm

## Double D-End Double Pedestal Base Tables.

2x weighted 600mm circular with 25mm thick top.

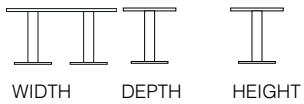
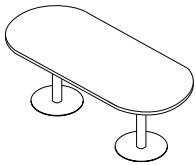

	WIDTH	DEPTH	HEIGHT
APED1608D074 *** **	1600mm	800mm	745mm
APED1809D074 *** **	1800mm	900mm	745mm
APED2010D074 *** **	2000mm	1000mm	745mm
APED1608D105 *** **	1600mm	800mm	1050mm
APED1809D105 *** **	1800mm	900mm	1050mm
APED2010D105 *** **	2000mm	1000mm	1050mm

## Peninsular P-End Double Pedestal Base Tables.

2x weighted circular with 25mm thick top.

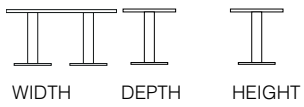
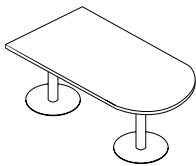

	WIDTH	DEPTH	HEIGHT
APED1608P074 *** **	1600mm	800mm	745mm
APED1809P074 *** **	1800mm	900mm	745mm
APED2010P074 *** **	2000mm	1000mm	745mm
APED1608P105 *** **	1600mm	800mm	1050mm
APED1809P105 *** **	1800mm	900mm	1050mm
APED2010P105 *** **	2000mm	1000mm	1050mm





# additions trumpet table

## HOW TO SPECIFY A TRUMPET BASE TABLE



For example, to specify a circular 800mm (d) x 740mm (h) additions table with oak top the code would be APED08CCHROMEMOK.  
All tops are in MFC.

Band 1 MFC Finishes		Band 2 MFC Finishes		Top Shape	Base Finish
White	WHM	Cashmere Grey	MSC	Circular	C
White/ Oak Edge	WHO	Antique Rose	MAR		Chrome
White/ Black Edge	WHB	Reed Green	MRG		CHROME
Pale Grey	MOG	Denim Blue	MDB		
Dust Grey	DGM	Hamilton Oak	MHO		
Light Oak*	MOK*	Nebraska Oak	MNO		
Walnut*	MOW*	Truffle Brown Oak	MDO		
		Natural Carini Walnut	MCW		
		Sevilla Ash	MSA		
		Chicago Concrete	MCC		

*\*Please note, we cannot guarantee continuity of these finishes.*

# additions trumpet base tables

## Circular Table with Trumpet Chrome Base.

No cable management available.

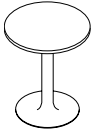

WIDTH



DEPTH



HEIGHT

APED06CCOFCHROME***	600mm	600mm	450mm
APED08CCOFCHROME***	800mm	800mm	450mm
APED06CCHROME***	600mm	600mm	720mm
APED08CCHROME***	800mm	800mm	720mm
APED09CCHROME***	900mm	900mm	720mm
APED10CCHROME***	1000mm	1000mm	720mm
APED12CCHROME***	1200mm	1200mm	720mm
APED06CPOSCHROME***	600mm	600mm	1050mm
APED08CPOSCHROME***	800mm	800mm	1050mm



# additions flip top tables

## HOW TO SPECIFY A FLIP TOP TABLE



CODE  
(E.G: 'FLIPEXEC')

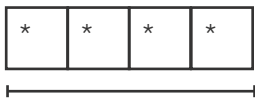

SIZE  
(E.G: '1208')



TOP COLOUR  
(E.G: 'WHM')

For example, to specify an Executive flip top table 1200mm (w) x 800mm (d) x 740mm (h) with a white top the code would be FLIPEXEC1208WHM. All tops are in MFC.

### Prestige/ V Steel Finishes

Silver	JOS
Graphite	GGS
White	JWS
Black	BLS

### Executive Steel Finishes

Nickel/Black	N/a
--------------	-----

### Band 1 MFC Finishes

White	WHM
White/ Oak Edge	WHO
White/ Black Edge	WHB
Pale Grey	MOG
Dust Grey	DGM
Light Oak*	MOK*
Walnut*	MOW*

*\*Please note, we cannot guarantee continuity of these finishes.*

### Band 2 MFC Finishes

Cashmere Grey	MSC
Antique Rose	MAR
Reed Green	MRG
Denim Blue	MDB
Hamilton Oak	MHO
Nebraska Oak	MNO
Truffle Brown Oak	MDO
Natural Carini Walnut	MCW
Sevilla Ash	MSA
Chicago Concrete	MCC



# additions flip top tables

## Prestige Flip Top Table.

Flip top table for nesting. Extended lead time.



	SHAPE	WIDTH	DEPTH	HEIGHT
ADTABFT1407RP *** **	Rectangular	1400mm	700mm	720mm
ADTABFT1607RP *** **	Rectangular	1600mm	700mm	720mm
ADTABFT1608RP *** **	Rectangular	1600mm	800mm	720mm
ADTABFT1808RP *** **	Rectangular	1800mm	800mm	720mm
ADTABFT14D7RP *** **	Semi-Circular	1400mm	700mm	720mm
ADTABFT16D8RP *** **	Semi-Circular	1600mm	800mm	720mm
ADTABFT14T7RP *** **	Trapezoidal	1400mm	606mm	720mm
ADTABFT16T8RP *** **	Trapezoidal	1600mm	693mm	720mm

## 'V' Flip Top Table.

Flip top table for nesting.

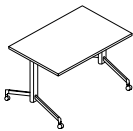

	SHAPE	WIDTH	DEPTH	HEIGHT
ADTABFT1407VS *** **	Rectangular	1400mm	700mm	720mm
ADTABFT1408VS *** **	Rectangular	1400mm	800mm	720mm
ADTABFT1608VS *** **	Rectangular	1600mm	800mm	720mm
ADTABFT1808VS *** **	Rectangular	1800mm	800mm	720mm
ADTABFT2008VS *** **	Rectangular	2000mm	800mm	720mm

## Executive Flip-Top Table with Black and Satin Nickel Base Only.

Pre-drilled for optional linking kits.



	SHAPE	WIDTH	DEPTH	HEIGHT
FLIPEXEC1208 ***	Rectangular	1200mm	800mm	720mm
FLIPEXEC1408 ***	Rectangular	1400mm	800mm	720mm
FLIPEXEC1608 ***	Rectangular	1600mm	800mm	720mm
FLIPEXEC1808 ***	Rectangular	1800mm	800mm	720mm
FLIPEXEC1575 ***	Rectangular	1500mm	750mm	720mm
FLIPEXECSEMI ***	Semi-Circular	1600mm	800mm	720mm

Linking Kit (FITKITPLAKOTOP)



# additons laptop table

## HOW TO SPECIFY A LAPTOP TABLE



CODE  
(E.G: 'ADDTABLT')

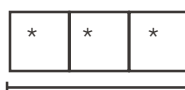

FRAME  
(EG: 'JWM')

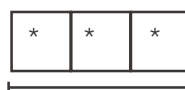

TOP  
(EG: 'MCW')

For example, to specify a Additions Laptop Table with a white frame and Natural Carini Walnut Top, the code will be ADDTABLTJWMMCW.

### Finishes

Black, Matt	BLM	Patina Green, Matt	GAM
Graphite Grey, Matt	GGM	Pale Green, Matt	GCM
Jot Silver, Matt	JOM	Sapphire Blue, Matt	USM
Pale Grey, Matt	PGM	Violet Blue, Matt	UVM
White, Matt	JWM	Distant Blue, Matt	UDM
Pale Brown, Matt	BPM	Pastel Blue, Matt	UPM
Grey Beige, Matt	BGM	Purple Red, Matt	RPM
Beige, Matt	BBM	Red Violet, Matt	RYM
Light Ivory, Matt	BIM	Orient Red, Matt	ROM
Olive Green, Matt	GOM	Beige Red, Matt	RBM
Fern Green, Matt	GFM	Tomato Red, Matt	RTM
Reed Green, Matt	GRM	Salmon Pink, Matt	PSM
Black Green, Matt	GBM	Yellow Orange, Matt	OYM
Pine Green, Matt	GPM	Broom Yellow, Matt	YBM

### Band 1 MFC Finishes

White	WHM
White/ Oak Edge	WHO
White/ Black Edge	WHB
Pale Grey	MOG
Dust Grey	DGM
Light Oak*	MOK*
Walnut*	MOW*

*\*Please note, we cannot guarantee continuity of these finishes.*





### Band 2 MFC Finishes

Cashmere Grey	MSC
Antique Rose	MAR
Reed Green	MRG
Denim Blue	MDB
Hamilton Oak	MHO
Nebraska Oak	MNO
Truffle Brown Oak	MDO
Natural Carini Walnut	MCW
Sevilla Ash	MSA
Chicago Concrete	MCC

# additons laptop table





## Additions Small Laptop Table

Fixed height. Table size: 550mm wide at front, 415mm wide at rear. 480mm deep.

			
	WIDTH	DEPTH	HEIGHT
ADDSMTABL*****	550mm	488mm	689mm

## Additions Laptop Table

Fixed height. Table size: 689mm wide at front, 520mm wide at rear. 480mm deep.

			
	WIDTH	DEPTH	HEIGHT
ADDTABL*****	689mm	488mm	689mm



# additions 2 tables

## HOW TO SPECIFY ADDITIONS 2 TABLES

Additions 2 has been designed for flexibility with shared components which can make up a number of tables. A table is made up from 3 codes: the MFC top (with or without cut out for data), the frame, and the legs.

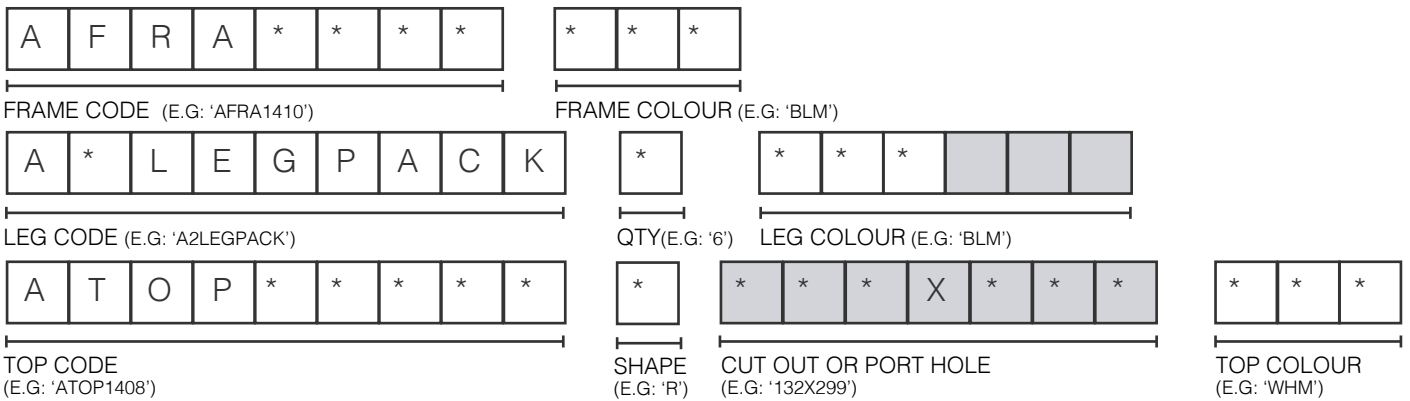

### Steel Finishes

Black, Matt	BLM	Patina Green, Matt
Graphite Grey, Matt	GGM	Pale Green, Matt
Jot Silver, Matt	JOM	Sapphire Blue, Matt
Pale Grey, Matt	PGM	Violet Blue, Matt
White, Matt	JWM	Distant Blue, Matt
Pale Brown, Matt	BPM	Pastel Blue, Matt
Grey Beige, Matt	BGM	Purple Red, Matt
Beige, Matt	BBM	Red Violet, Matt
Light Ivory, Matt	BIM	Orient Red, Matt
Olive Green, Matt	GOM	Beige Red, Matt
Fern Green, Matt	GFM	Tomato Red, Matt
Reed Green, Matt	GRM	Salmon Pink, Matt
Black Green, Matt	GBM	Yellow Orange, Matt
Pine Green, Matt	GPM	Broom Yellow, Matt

### Band 1 MFC Finishes

GAM	White
GCM	White/ Oak Edge
USM	White/ Black Edge
UVM	Pale Grey
UDM	Dust Grey
UPM	Light Oak*
RPM	Walnut*
RYM	
ROM	
RBM	
RTM	
PSM	
OYM	
YBM	

\*Please note, we cannot guarantee continuity of these finishes.

### Band 2 MFC Finishes

WHM	Cashmere Grey	MSC
WHO	Antique Rose	MAR
WHB	Reed Green	MRG
MOG	Denim Blue	MDB
DGM	Hamilton Oak	MHO
MOK*	Nebraska Oak	MNO
MOW*	Truffle Brown Oak	MDO
	Natural Carini Walnut	MCW
	Sevilla Ash	MSA
	Chicago Concrete	MCC

# additions 2 tables

## /rectangular table components

### Rectangular MFC Top.

Without port holes or cut out. Overall desk height 740mm.

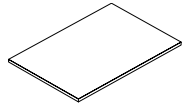

WIDTH      DEPTH      HEIGHT

### + Frames

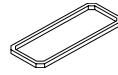

FRAME

### + Legs



LEGS.  
(3 OPTIONS)

#### Comes in 1 piece

ATOP0808R ***	800mm	800mm	25mm	AFRA0808 ***
ATOP1008R ***	1000mm	800mm	25mm	AFRA1008 ***
ATOP1208R ***	1200mm	800mm	25mm	AFRA1208 ***
ATOP1408R ***	1400mm	800mm	25mm	AFRA1408 ***
ATOP1608R ***	1600mm	800mm	25mm	AFRA1608 ***
ATOP1808R ***	1800mm	800mm	25mm	AFRA1808 ***
ATOP2008R ***	2000mm	800mm	25mm	AFRA2008 ***
ATOP1010R ***	1000mm	1000mm	25mm	AFRA1010 ***
ATOP1210R ***	1200mm	1000mm	25mm	AFRA1210 ***
ATOP1410R ***	1400mm	1000mm	25mm	AFRA1410 ***
ATOP1610R ***	1600mm	1000mm	25mm	AFRA1610 ***
ATOP1810R ***	1800mm	1000mm	25mm	AFRA1810 ***
ATOP2010R ***	2000mm	1000mm	25mm	AFRA2010 ***
ATOP2210R ***	2200mm	1000mm	25mm	AFRA2210 ***
ATOP2410R ***	2400mm	1000mm	25mm	AFRA2410 ***
ATOP1212R ***	1200mm	1200mm	25mm	AFRA1212 ***
ATOP1812R ***	1800mm	1200mm	25mm	AFRA1812 ***
ATOP2012R ***	2000mm	1200mm	25mm	AFRA2012 ***
ATOP2212R ***	2200mm	1200mm	25mm	AFRA2212 ***
ATOP2412R ***	2400mm	1200mm	25mm	AFRA2412 ***

#### Comes in 2 Pieces - Order 2

Width is the size of 2 separate tops combined.

ATOP1410R ***	2800mm	1000mm	25mm	AFRA2810 ***
ATOP1610R ***	3200mm	1000mm	25mm	AFRA3210 ***
ATOP1810R ***	3600mm	1000mm	25mm	AFRA3610 ***
ATOP2010R ***	4000mm	1000mm	25mm	AFRA4010 ***
ATOP1412R ***	2800mm	1200mm	25mm	AFRA2812 ***
ATOP1612R ***	3200mm	1200mm	25mm	AFRA3212 ***
ATOP1812R ***	3600mm	1200mm	25mm	AFRA3612 ***
ATOP2012R ***	4000mm	1200mm	25mm	AFRA4012 ***
ATOP1416R ***	2800mm	1600mm	25mm	AFRA2816 ***
ATOP1616R ***	3200mm	1600mm	25mm	AFRA3216 ***
ATOP1816R ***	3600mm	1600mm	25mm	AFRA3616 ***
ATOP2016R ***	4000mm	1600mm	25mm	AFRA4016 ***

This table requires  
4 legs, order either  
powder coated  
legs: A\*LEG-  
715PK4\*\*\*  
or chrome legs:  
A\*LEG715PK-  
4CHROME or  
wooden legs:  
A4LEG715PK4 \*\*\*  
OAK

This table requires 6  
legs, order either  
powder coated  
legs: A\*LEG-  
715PK6\*\*\*  
or chrome legs:  
A\*LEG715PK-  
6CHROME or  
wooden legs:  
A6LEG715PK4 \*\*\*  
OAK

# /rectangular table components with power

## Rectangular MFC Top.

With port holes or cut out. Overall desk height 740mm.

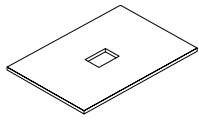

## + Frames.

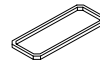

FRAME

## + Legs.



LEGS.  
(3 OPTIONS)

### Comes in 1 piece

ATOP0808R *** *****	800mm	800mm	25mm
ATOP1008R *** *****	1000mm	800mm	25mm
ATOP1208R *** *****	1200mm	800mm	25mm
ATOP1408R *** *****	1400mm	800mm	25mm
ATOP1608R *** *****	1600mm	800mm	25mm
ATOP1808R *** *****	1800mm	800mm	25mm
ATOP2008R *** *****	2000mm	800mm	25mm

AFRA0808 ***
AFRA1008 ***
AFRA1208 ***
AFRA1408 ***
AFRA1608 ***
AFRA1808 ***
AFRA2008 ***

This table requires 4 legs, order either powder coated legs: A\*LEG715PK4\*\*\* or chrome legs: A\*LEG715PK4CHROME or wooden legs: A4LEG-715PK4 \*\*\* OAK

ATOP1010R *** *****	1000mm	1000mm	25mm
ATOP1210R *** *****	1200mm	1000mm	25mm
ATOP1410R *** *****	1400mm	1000mm	25mm
ATOP1610R *** *****	1600mm	1000mm	25mm
ATOP1810R *** *****	1800mm	1000mm	25mm
ATOP2010R *** *****	2000mm	1000mm	25mm
ATOP2210R *** *****	2200mm	1000mm	25mm
ATOP2410R *** *****	2400mm	1000mm	25mm

AFRA1010 ***
AFRA1210 ***
AFRA1410 ***
AFRA1610 ***
AFRA1810 ***
AFRA2010 ***
AFRA2210 ***
AFRA2410 ***

ATOP1212R *** *****	1200mm	1200mm	25mm
ATOP1812R *** *****	1800mm	1200mm	25mm
ATOP2012R *** *****	2000mm	1200mm	25mm
ATOP2212R *** *****	2200mm	1200mm	25mm
ATOP2412R *** *****	2400mm	1200mm	25mm

AFRA1212 ***
AFRA1812 ***
AFRA2012 ***
AFRA2212 ***
AFRA2412 ***

### Comes in 2 Pieces - Order 2

Width is the size of 2 separate tops combined. 1 cut out per top

ATOP1410R *** *****	2800mm	1000mm	25mm
ATOP1610R *** *****	3200mm	1000mm	25mm
ATOP1810R *** *****	3600mm	1000mm	25mm
ATOP2010R *** *****	4000mm	1000mm	25mm

AFRA2810 ***
AFRA3210 ***
AFRA3610 ***
AFRA4010 ***

This table requires 6 legs, order either powder coated legs: A\*LEG715PK6\*\*\* or chrome legs: A\*LEG715PK6CHROME or wooden legs: A6LEG-715PK4 \*\*\* OAK

ATOP1412R *** *****	2800mm	1200mm	25mm
ATOP1612R *** *****	3200mm	1200mm	25mm
ATOP1812R *** *****	3600mm	1200mm	25mm
ATOP2012R *** *****	4000mm	1200mm	25mm

AFRA2812 ***
AFRA3212 ***
AFRA3612 ***
AFRA4012 ***

ATOP1416R *** *****	2800mm	1600mm	25mm
ATOP1616R *** *****	3200mm	1600mm	25mm
ATOP1816R *** *****	3600mm	1600mm	25mm
ATOP2016R *** *****	4000mm	1600mm	25mm

AFRA2816 ***
AFRA3216 ***
AFRA3616 ***
AFRA4016 ***

### Tip

When specifying a cut out MFC top, the order of the cut out dimensions placed within the code changes the orientation of the cut out. For example, a ATOP1408R132X299WHM would get a different cut out to a ATOP1408R299X132WHM. The first measurement in the code is the side of the cut out parallel to the width of the desk.

# /shaped table components

## Barrel MFC Top.

Without port holes or cut outs. Overall desk height 740mm.

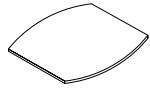

ATOP2412B \*\*\*

WIDTH	DEPTH	HEIGHT
2400mm	1200mm	25mm

## + Frames.

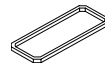

FRAME

AFRA2410 \*\*\*

## + Legs.



LEGS.  
(3 OPTIONS)

A\*LEG715PK4\*\*\* \*\*

## Circular MFC Top.

Without port holes or cut outs. Overall desk height 740mm.

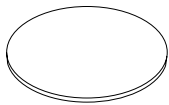

ATOP08C \*\*\*

ATOP09C \*\*\*

ATOP10C \*\*\*

ATOP12C \*\*\*

ATOP14C \*\*\*

ATOP15C \*\*\*

DIAMETER	HEIGHT	-
800mm	25mm	-
900mm	25mm	-
1000mm	25mm	-
1200mm	25mm	-
1400mm	25mm	-
1500mm	25mm	-

## + Frames.

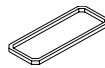

FRAME

AFRA0606 \*\*\*

AFRA0606 \*\*\*

AFRA0606 \*\*\*

AFRA0808 \*\*\*

AFRA1010 \*\*\*

AFRA1010 \*\*\*

## + Legs.



LEGS.  
(3 OPTIONS)

A\*LEG715PK4\*\*\* \*\*

A\*LEG715PK4\*\*\* \*\*

A\*LEG715PK4\*\*\* \*\*

A\*LEG715PK4\*\*\* \*\*

A\*LEG715PK4\*\*\* \*\*

A\*LEG715PK4\*\*\* \*\*

## Double 'D' End MFC Top.

Without port holes or cut outs. Overall desk height 740mm.



ATOP2010D \*\*\*

ATOP2412D \*\*\*

WIDTH	DEPTH	HEIGHT
2000mm	1000mm	25mm
2400mm	1200mm	25mm

## + Frames.

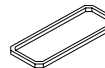

FRAME

AFRA1408 \*\*\*

AFRA1610 \*\*\*

## + Legs.



LEGS.  
(3 OPTIONS)

A\*LEG715PK4\*\*\* \*\*

A\*LEG715PK4\*\*\* \*\*

## Elliptical MFC Top.

Without port holes or cut outs. Overall desk height 740mm.



ATOP2412E \*\*\*

WIDTH	DEPTH	HEIGHT
2400mm	1200mm	25mm

## + Frames.

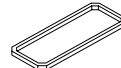

FRAME

AFRA1608 \*\*\*

## + Legs.



LEGS.  
(3 OPTIONS)

A\*LEG715PK4\*\*\* \*\*

# /shaped table components with power

## Barrel MFC Top.

With port holes or cut outs. Overall desk height 740mm.

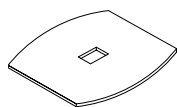

ATOP2412B \*\*\* \*\*\*\*\*

2400mm 1200mm 25mm

## + Frames.

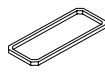

FRAME

AFRA2410 \*\*\*

## + Legs.



LEGS.  
(3 OPTIONS)

A\*LEG715PK4\*\*\* \*\* \*

## Circular MFC Top.

With port holes or cut outs. Overall desk height 740mm.

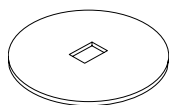

ATOP08C \*\*\* \*\*\*\*\*

800mm 25mm -

ATOP09C \*\*\* \*\*\*\*\*

900mm 25mm -

ATOP10C \*\*\* \*\*\*\*\*

1000mm 25mm -

ATOP12C \*\*\* \*\*\*\*\*

1200mm 25mm -

ATOP14C \*\*\* \*\*\*\*\*

1400mm 25mm -

ATOP15C \*\*\* \*\*\*\*\*

1500mm 25mm -

## + Frames.

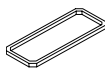

FRAME

AFRA0606 \*\*\*

AFRA0606 \*\*\*

AFRA0606 \*\*\*

AFRA0808 \*\*\*

AFRA1010 \*\*\*

AFRA1010 \*\*\*

## + Legs.



LEGS.  
(3 OPTIONS)

A\*LEG715PK4\*\*\* \*\* \*

A\*LEG715PK4\*\*\* \*\* \*

A\*LEG715PK4\*\*\* \*\* \*

A\*LEG715PK4\*\*\* \*\* \*

A\*LEG715PK4\*\*\* \*\* \*

A\*LEG715PK4\*\*\* \*\* \*

## Double 'D' End MFC Top.

With port holes or cut outs. Overall desk height 740mm.

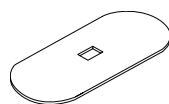

ATOP2010D \*\*\* \*\*\*\*\*

2000mm 1000mm 25mm

ATOP2412D \*\*\* \*\*\*\*\*

2400mm 1200mm 25mm

## + Frames.

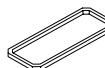

FRAME

AFRA1408 \*\*\*

AFRA1610 \*\*\*

## + Legs.



LEGS.  
(3 OPTIONS)

A\*LEG715PK4\*\*\* \*\* \*

A\*LEG715PK4\*\*\* \*\* \*

## Elliptical MFC Top.

With port holes or cut outs. Overall desk height 740mm.

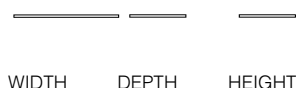
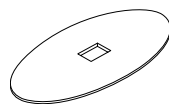

ATOP2412E \*\*\* \*\*\*\*\*

2400mm 1200mm 25mm

## + Frames.

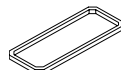

FRAME

AFRA1608 \*\*\*

## + Legs.



LEGS.  
(3 OPTIONS)

A\*LEG715PK4\*\*\* \*\* \*



# /legs

## Spider Legs (4 or 6 Pack).

A2 Legs come in 4 pack or 6 pack. Overall desk height 740mm. For powder coated legs DO NOT include 'CHROME' at end of code. For chrome legs replace '\*\*\*' with 'CHROME', eg, A2LEG715PK6CHROME.



A2LEG715PK4 *** CHROME	60mm	30mm	715mm
A2LEG715PK6 *** CHROME	60mm	30mm	715mm

## Torch Legs (4 or 6 Pack).

A3 Legs come in 4 pack or 6 pack. Overall desk height 740mm. For powder coated legs DO NOT include 'CHROME' at end of code. For chrome legs replace '\*\*\*' with 'CHROME', eg, A3LEG715PK6CHROME.



A3LEG715PK4 *** CHROME	60mm	30mm	715mm
A3LEG715PK6 *** CHROME	60mm	30mm	715mm

## Wilson Legs (4 or 6 Pack).

A4 Legs come in 4 pack or 6 pack. Overall desk height 740mm. Solid oak legs with clear lacquer, please be aware of colour matching this product, the legs will age naturally.

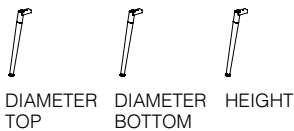

A4LEG715PK4 *** OAK	60mm	40mm	715mm
A4LEG715PK6 *** OAK	60mm	40mm	715mm

# /cable management

To calculate correct cable management basket or tray for tables, use the size of MFC top and deduct 400mm off the width size. This will ensure the tray/basket sits inside the frame. If the MFC top comes in 2 parts, half the width to get the individual top size, then deduct 400mm.

If users are sat at shortest ends of the table, you should further reduce the length of the cable tray by 400mm to allow for knees. See diagram below.

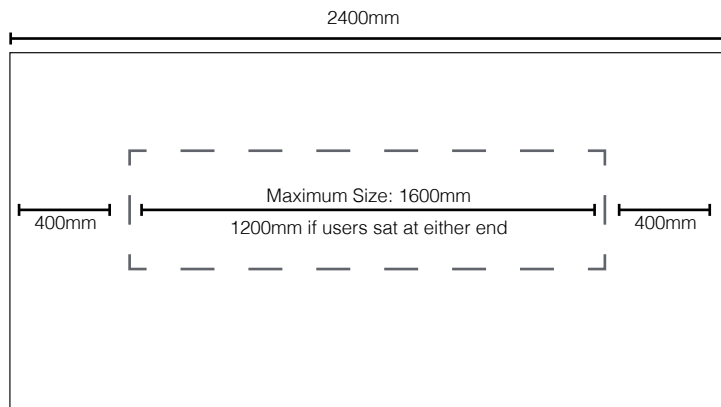

## Cable Tray.

Wood screws included. Height: 200mm.

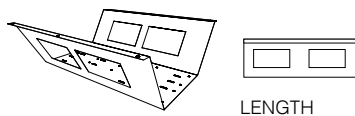

ATRAY400***	400mm
ATRAY600***	600mm
ATRAY800***	800mm
ATRAY1000***	1000mm
ATRAY1200***	1200mm
ATRAY1400***	1400mm
ATRAY1600***	1600mm

## Square Cable Tower with Removable Door.

Screws directly in to underside of table tops. Adjustable feet.

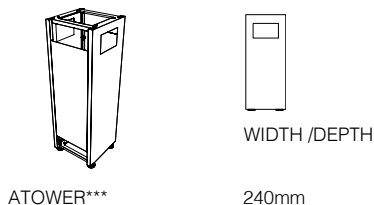

ATOWER***	240mm
-----------	-------

# /coffee table

## Circular Coffee Table

A2 powder coated leg coffee table.

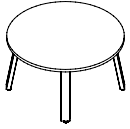

WIDTH



DEPTH



HEIGHT

A2COF08C \*\*\* \*\*

800mm

800mm

450mm

A2COF10C \*\*\* \*\*

1000mm

1000mm

450mm

## Rectangular Coffee Table

A2 powder coated leg coffee table.

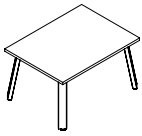

WIDTH



DEPTH



HEIGHT

A2COF0806R \*\*\* \*\*

800mm

600mm

450mm

A2COF1006R \*\*\* \*\*

1000mm

600mm

450mm

A2COF0808R \*\*\* \*\*

800mm

800mm

450mm

A2COF1008R \*\*\* \*\*

1000mm

800mm

450mm



parq

## HOW TO SPECIFY PARQ

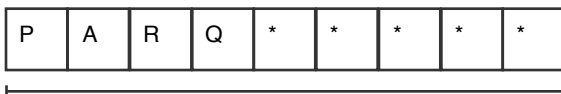

CODE  
(E.G: 'PARQ2008T')



STEEL COLOUR  
(E.G: 'BLM')

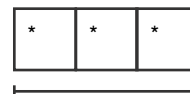

TOP COLOUR  
(E.G: 'L02')

For example, to specify a 50mm laminate premium white and black frame parq table and two benches the codes would be PARQ2008TBLML02 (x1), PARQ2003BBLML02 (x2). When ordering a bench consider attachable seat pads. Parq seat pads are available in various materials, for the full range please see the seat pad section.

### Finishes

Black, Matt	BLM	Patina Green, Matt	GAM
Graphite Grey, Matt	GGM	Pale Green, Matt	GCM
Jot Silver, Matt	JOM	Sapphire Blue, Matt	USM
Pale Grey, Matt	PGM	Violet Blue, Matt	UVM
White, Matt	JWM	Distant Blue, Matt	UDM
Pale Brown, Matt	BPM	Pastel Blue, Matt	UPM
Grey Beige, Matt	BGM	Purple Red, Matt	RPM
Beige, Matt	BBM	Red Violet, Matt	RYM
Light Ivory, Matt	BIM	Orient Red, Matt	ROM
Olive Green, Matt	GOM	Beige Red, Matt	RBM
Fern Green, Matt	GFM	Tomato Red, Matt	RTM
Reed Green, Matt	GRM	Salmon Pink, Matt	PSM
Black Green, Matt	GBM	Yellow Orange, Matt	OYM
Pine Green, Matt	GPM	Broom Yellow, Matt	YBM

### Band 1 MFC Finishes

White	WHM
White/ Oak Edge	WHO
White/ Black Edge	WHB
Pale Grey	MOG
Dust Grey	DGM
Light Oak*	MOK*
Walnut*	MOW*

*\*Please note, we cannot guarantee continuity of these finishes.*

### Band 2 MFC Finishes

Cashmere Grey	MSC
Antique Rose	MAR
Reed Green	MRG
Denim Blue	MDB
Hamilton Oak	MHO
Nebraska Oak	MNO
Truffle Brown Oak	MDO
Natural Carini Walnut	MCW
Sevilla Ash	MSA
Chicago Concrete	MCC

### Band 1 Laminate Finishes

White	L02
Pale Grey	L06
Dust Grey	L23

### Band 2 Laminate Finishes

Cashmere Grey	L19
Antique Rose	L20
Reed Green	L22
Denim Blue	L21
Hamilton Oak	L15
Nebraska Oak	L11
Truffle Brown Oak	L16
Natural Carini Walnut	L17
Sevilla Ash	L14
Chicago Concrete	L18

# parq tables /mfc tops

## Dining Bench.

25mm MFC top.

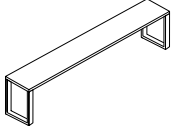

WIDTH      DEPTH      HEIGHT

PARQ1203B *** **	1050mm	350mm	410mm
PARQ1403B *** **	1250mm	350mm	410mm
PARQ1603B *** **	1450mm	350mm	410mm
PARQ1803B *** **	1650mm	350mm	410mm
PARQ2003B *** **	1850mm	350mm	410mm
PARQ2203B *** **	2050mm	350mm	410mm
PARQ2403B *** **	2250mm	350mm	410mm

## Dining Standalone or Starter Table.

25mm MFC top.

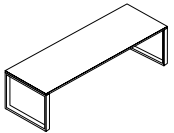

WIDTH      DEPTH      HEIGHT

PARQ1208T *** **	1200mm	800mm	735mm
PARQ1408T *** **	1400mm	800mm	735mm
PARQ1608T *** **	1600mm	800mm	735mm
PARQ1808T *** **	1800mm	800mm	735mm
PARQ2008T *** **	2000mm	800mm	735mm
PARQ2208T *** **	2200mm	800mm	735mm
PARQ2408T *** **	2400mm	800mm	735mm

## Dining Extension Table.

25mm MFC top.

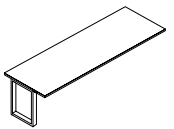

WIDTH      DEPTH      HEIGHT

PARQEXT1208T *** **	1200mm	800mm	735mm
PARQEXT1408T *** **	1400mm	800mm	735mm
PARQEXT1608T *** **	1600mm	800mm	735mm
PARQEXT1808T *** **	1800mm	800mm	735mm
PARQEXT2008T *** **	2000mm	800mm	735mm
PARQEXT2208T *** **	2200mm	800mm	735mm
PARQEXT2408T *** **	2400mm	800mm	735mm

**Poseur Standalone or Starter Table.**

25mm MFC top.

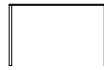
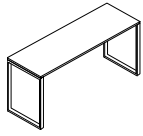

WIDTH      DEPTH      HEIGHT

PARQ1208P *** **	1200mm	800mm	1025mm
PARQ1408P *** **	1400mm	800mm	1025mm
PARQ1608P *** **	1600mm	800mm	1025mm
PARQ1808P *** **	1800mm	800mm	1025mm
PARQ2008P *** **	2000mm	800mm	1025mm
PARQ2208P *** **	2200mm	800mm	1025mm
PARQ2408P *** **	2400mm	800mm	1025mm

**Poseur Extension Table.**

25mm MFC top.

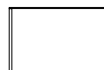
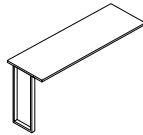

WIDTH      DEPTH      HEIGHT

PARQEXT1208P *** **	1200mm	800mm	1025mm
PARQEXT1408P *** **	1400mm	800mm	1025mm
PARQEXT1608P *** **	1600mm	800mm	1025mm
PARQEXT1808P *** **	1800mm	800mm	1025mm
PARQEXT2008P *** **	2000mm	800mm	1025mm
PARQEXT2208P *** **	2200mm	800mm	1025mm
PARQEXT2408P *** **	2400mm	800mm	1025mm

# /laminated tops

**Dining Bench.**

50mm high pressure laminate top.

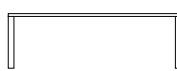
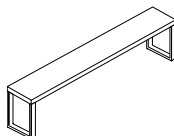

WIDTH      DEPTH      HEIGHT

PARQ1203B *** **	1050mm	350mm	435mm
PARQ1403B *** **	1250mm	350mm	435mm
PARQ1603B *** **	1450mm	350mm	435mm
PARQ1803B *** **	1650mm	350mm	435mm
PARQ2003B *** **	1850mm	350mm	435mm
PARQ2203B *** **	2050mm	350mm	435mm
PARQ2403B *** **	2250mm	350mm	435mm

**Dining Standalone/ Starter Table.**

50mm high pressure laminate top.

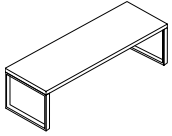

	WIDTH	DEPTH	HEIGHT
--	-------	-------	--------

PARQ1208T *** **	1200mm	800mm	760mm
PARQ1408T *** **	1400mm	800mm	760mm
PARQ1608T *** **	1600mm	800mm	760mm
PARQ1808T *** **	1800mm	800mm	760mm
PARQ2008T *** **	2000mm	800mm	760mm
PARQ2208T *** **	2200mm	800mm	760mm
PARQ2408T *** **	2400mm	800mm	760mm

**Dining Extension Table.**

50mm high pressure laminate top.

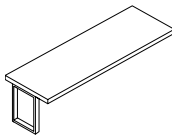

	WIDTH	DEPTH	HEIGHT
--	-------	-------	--------

PARQEXT1208T *** **	1200mm	800mm	760mm
PARQEXT1408T *** **	1400mm	800mm	760mm
PARQEXT1608T *** **	1600mm	800mm	760mm
PARQEXT1808T *** **	1800mm	800mm	760mm
PARQEXT2008T *** **	2000mm	800mm	760mm
PARQEXT2208T *** **	2200mm	800mm	760mm
PARQEXT2408T *** **	2400mm	800mm	760mm

**Poseur Standalone/ Starter Table.**

50mm high pressure laminate top.

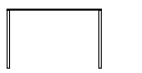
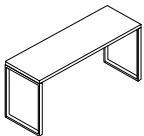

	WIDTH	DEPTH	HEIGHT
--	-------	-------	--------

PARQ1208P *** **	1200mm	800mm	1050mm
PARQ1408P *** **	1400mm	800mm	1050mm
PARQ1608P *** **	1600mm	800mm	1050mm
PARQ1808P *** **	1800mm	800mm	1050mm
PARQ2008P *** **	2000mm	800mm	1050mm
PARQ2208P *** **	2200mm	800mm	1050mm
PARQ2408P *** **	2400mm	800mm	1050mm

**Poseur Extension Table.**

50mm high pressure laminate top.

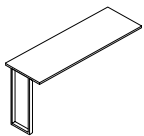

	WIDTH	DEPTH	HEIGHT
--	-------	-------	--------

PARQEXT1208P *** **	1200mm	800mm	1050mm
PARQEXT1408P *** **	1400mm	800mm	1050mm
PARQEXT1608P *** **	1600mm	800mm	1050mm
PARQEXT1808P *** **	1800mm	800mm	1050mm
PARQEXT2008P *** **	2000mm	800mm	1050mm
PARQEXT2208P *** **	2200mm	800mm	1050mm
PARQEXT2408P *** **	2400mm	800mm	1050mm

# /accessories

Complete with velcro straps to securely fasten to bench seating.  
Please refer to Camira for codes, samples and colour swatches.

## Vinyl Cushion Seat Pad.

Select from Chieftain 'Just Colour', Camira Phoenix or Camira Advantage.

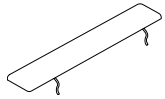

WIDTH      DEPTH      HEIGHT

PARQ1203C ***	1050mm	350mm	400mm
PARQ1403C ***	1250mm	350mm	400mm
PARQ1603C ***	1450mm	350mm	400mm
PARQ1803C ***	1650mm	350mm	400mm
PARQ2003C ***	1850mm	350mm	400mm
PARQ2203C ***	2050mm	350mm	400mm
PARQ2403C ***	2250mm	350mm	400mm







larke

## HOW TO SPECIFY LARKE



For example, to specify a Poseur height 2400mm x 1000mm high table in pale green and oak top, static leg and no electrics, the code will be LT2410GSGCMMOK, and to add planters, the code would be LPBGCM.

### Steel Finishes

Black, Matt	BLM
Graphite Grey, Matt	GGM
Jot Silver, Matt	JOM
Pale Grey, Matt	PGM
White, Matt	JWM
Pale Brown, Matt	BPM
Grey Beige, Matt	BGM
Beige, Matt	BBM
Light Ivory, Matt	BIM
Olive Green, Matt	GOM
Fern Green, Matt	GFM
Reed Green, Matt	GRM
Black Green, Matt	GBM
Pine Green, Matt	GPM
Patina Green, Matt	GAM
Pale Green, Matt	GCM
Sapphire Blue, Matt	USM
Violet Blue, Matt	UVM
Distant Blue, Matt	UDM
Pastel Blue, Matt	UPM
Purple Red, Matt	RPM

Red Violet, Matt	RYM
Orient Red, Matt	ROM
Beige Red, Matt	RBM
Tomato Red, Matt	RTM
Salmon Pink, Matt	PSM
Yellow Orange, Matt	OYM
Broom Yellow, Matt	YBM
<b>Band 1 MFC Finishes</b>	
White	WHM
White/ Oak Edge	WHO
White/ Black Edge	WHB
Pale Grey	MOG
Dust Grey	DGM
Light Oak*	MOK*
Walnut*	MOW*

\*Please note, we cannot guarantee continuity of these finishes.

### Band 2 MFC Finishes

Cashmere Grey	MSC
Antique Rose	MAR
Reed Green	MRG
Denim Blue	MDB
Hamilton Oak	MHO
Nebraska Oak	MNO
Truffle Brown Oak	MDO
Natural Carini Walnut	MCW
Sevilla Ash	MSA
Chicago Concrete	MCC

### Electric Cut Out Sizes

80mm Diameter for	A
Pluto, Neptune, Pixel, Porthole	
128mm Diameter for	B
Pandora Power Module	
163mm x 69mm for	C
Surface Power Module	
263mm x 69mm for	D
Surface Power Module	
363mm x 69mm for	E
Surface Power Module	
463mm x 69mm for	F
Surface Power Module	

# larke

## /static leg

### Larke Dining Height Work Table

Static feet, plain tops, no cut-outs. 1800mm wide tables do not have an recessed intermediate leg.



WIDTH



DEPTH

TABLE  
HEIGHTOVERALL  
HEIGHT

LT1810GS *** **	1800mm	1000mm	740mm	1940mm
LT2410GS *** **	2400mm	1000mm	740mm	1940mm
LT3010GS *** **	3000mm	1000mm	740mm	1940mm
LT3610GS *** **	3600mm	1000mm	740mm	1940mm

### Larke Dining Height Work Table with Electric Cut Out

Static feet. 1 cut out for 1800mm tables. 2 per 2400mm, 3000mm and 3600mm wide tables.

Electrics and cable management to be ordered separately.

1800mm wide tables do not have an recessed intermediate leg.



WIDTH



DEPTH

TABLE  
HEIGHTOVERALL  
HEIGHT

LT1810GS PWR * ** **	1800mm	1000mm	740mm	1940mm
LT2410GS PWR * ** **	2400mm	1000mm	740mm	1940mm
LT3010GS PWR * ** **	3000mm	1000mm	740mm	1940mm
LT3610GS PWR * ** **	3600mm	1000mm	740mm	1940mm

### Larke Poseur Height Work Table

Static feet, plain tops, no cut-outs. 1800mm wide tables do not have an recessed intermediate leg.

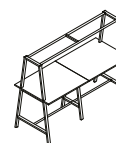

WIDTH



DEPTH

TABLE  
HEIGHTOVERALL  
HEIGHT

LP1810GS *** **	1800mm	1000mm	1100mm	1940mm
LP2410GS *** **	2400mm	1000mm	1100mm	1940mm
LP3010GS *** **	3000mm	1000mm	1100mm	1940mm
LP3610GS *** **	3600mm	1000mm	1100mm	1940mm

### Larke Poseur Height Work Table with Electric Cut Out

Static feet. 1 cut out for 1800mm tables. 2 per 2400mm, 3000mm and 3600mm wide tables.

Electrics and cable management to be ordered separately.

1800mm wide tables do not have an recessed intermediate leg.



WIDTH



DEPTH





TABLE  
HEIGHTOVERALL  
HEIGHT

LP1810GS PWR * ** **	1800mm	1000mm	1100mm	1940mm
LP2410GS PWR * ** **	2400mm	1000mm	1100mm	1940mm
LP3010GS PWR * ** **	3000mm	1000mm	1100mm	1940mm
LP3610GS PWR * ** **	3600mm	1000mm	1100mm	1940mm

# /castors

## Larke Dining Height Work Table with Castors.

Mobile castors, plain tops, no cut-outs. 1800mm wide tables do not have an recessed intermediate leg.





				
	WIDTH	DEPTH	TABLE HEIGHT	OVERALL HEIGHT
LT1810GM *** **	1800mm	1000mm	740mm	1940mm
LT2410GM *** **	2400mm	1000mm	740mm	1940mm
LT3010GM *** **	3000mm	1000mm	740mm	1940mm
LT3610GM *** **	3600mm	1000mm	740mm	1940mm

## Larke Dining Height Work Table with Electric Cut Out & Castors.

Mobile castors, 1 cut out for 1800mm tables. 2 per 2400mm, 3000mm and 3600mm wide tables.





Electrics and cable management to be ordered seperately.

1800mm wide tables do not have an recessed intermediate leg.

				
	WIDTH	DEPTH	TABLE HEIGHT	OVERALL HEIGHT
LT1810GM PWR * ** **	1800mm	1000mm	740mm	1940mm
LT2410GM PWR * ** **	2400mm	1000mm	740mm	1940mm
LT3010GM PWR * ** **	3000mm	1000mm	740mm	1940mm
LT3610GM PWR * ** **	3600mm	1000mm	740mm	1940mm

## Larke Poseur Height Work Table with Castors.

Mobile castors, plain tops, no cut-outs. 1800mm wide tables do not have an recessed intermediate leg.





				
	WIDTH	DEPTH	TABLE HEIGHT	OVERALL HEIGHT
LP1810GM *** **	1800mm	1000mm	1100mm	1940mm
LP2410GM *** **	2400mm	1000mm	1100mm	1940mm
LP3010GM *** **	3000mm	1000mm	1100mm	1940mm
LP3610GM *** **	3600mm	1000mm	1100mm	1940mm

## Larke Poseur Height Work Table with Electric Cut Out & Castors.

Mobile castors, 1 cut out for 1800mm tables. 2 per 2400mm, 3000mm and 3600mm wide tables.

Electrics and cable management to be ordered seperately.

1800mm wide tables do not have an recessed intermediate leg.

				
	WIDTH	DEPTH	TABLE HEIGHT	OVERALL HEIGHT
LP1810GM PWR * ** **	1800mm	1000mm	1100mm	1940mm
LP2410GM PWR * ** **	2400mm	1000mm	1100mm	1940mm
LP3010GM PWR * ** **	3000mm	1000mm	1100mm	1940mm
LP3610GM PWR * ** **	3600mm	1000mm	1100mm	1940mm

## /accessories

**Monitor Bracket for 32"-40" TVs.** TV not included.

For Dining Height Tables. LTMB \*\*\*.

For Poseur Height Tables. LPMB \*\*\*.

**Magentic Cable Riser.** Steel finishes.

320mm Long. LCR320 \*\*\*.

550mm Long. LCR550 \*\*\*.

**Gantry Planter Box with Enclosed Waterproof Tray.**

LPB\*\*\*.

**Gantry Mesh Tray for Hanging Plants or Lighting.**

LTR\*\*\*.

**Fabric Cable Riser.**

Upholstered in Camira Blazer Lite Black (LTH69), Dark Grey (LTH70) and Light Grey (LTH39)

720mm Long. LFTCR \*\*\*\*\*.

950mm Long. LFPCR \*\*\*\*\*.



# channel work table

## HOW TO SPECIFY CHANNEL WORK TABLE

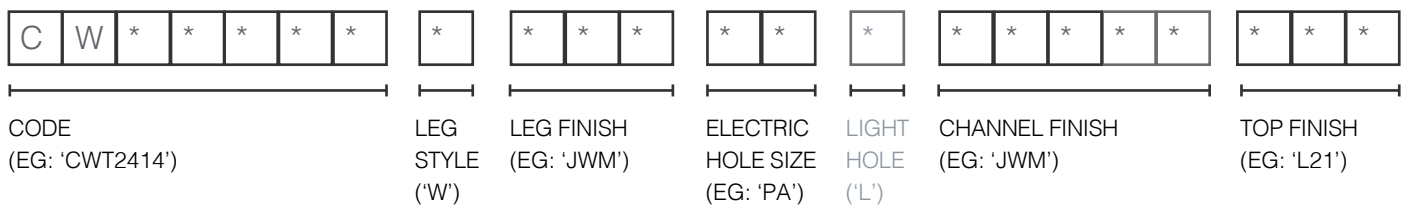

For example, to specify a 2400mm x 1400mm x 755mm Channel Work Table with Denim Blue top, white metal central channel, white lights, white pandora electrics and white wire legs the code would be CWT2414WJWMPALJWML21, CWT2LIGHTR-3 and CWT3PAN WHP -3

### Steel Channel/ Wire Leg Finishes

Ferro Clear Lacquer	CCG
Black, Matt	BLM
Graphite Grey, Matt	GGM
Jot Silver, Matt	JOM
Pale Grey, Matt	PGM
White, Matt	JWM
Pale Brown, Matt	BPM
Grey Beige, Matt	BGM
Beige, Matt	BBM
Light Ivory, Matt	BIM
Olive Green, Matt	GOM
Fern Green, Matt	GFM
Reed Green, Matt	GRM
Black Green, Matt	GBM
Pine Green, Matt	GPM
Patina Green, Matt	GAM
Pale Green, Matt	GCM
Sapphire Blue, Matt	USM
Violet Blue, Matt	UVM
Distant Blue, Matt	UDM

Pastel Blue, Matt	UPM
Purple Red, Matt	RPM
Red Violet, Matt	RYM
Orient Red, Matt	ROM
Beige Red, Matt	RBM
Tomato Red, Matt	RTM
Salmon Pink, Matt	PSM
Yellow Orange, Matt	OYM
Broom Yellow, Matt	YBM

### Fabric Channels Finishes

Camira Blazer
Camira Synergy

### Band 1 Laminate Finishes

White	L02
Pale Grey	L06
Dust Grey	L23

### Band 2 Laminate Finishes

Cashmere Grey	L19
Antique Rose	L20
Reed Green	L22
Denim Blue	L21
Hamilton Oak	L15
Nebraska Oak	L11
Truffle Brown Oak	L16
Natural Carini Walnut	L17
Sevilla Ash	L14
Chicago Concrete	L18

### Fenix® Worktops

Blanco Alaska 0030	F01
Nero Ingo 0720	F03
Grigio Bromo 0724	F05
Grigio Efeso 0725	F06
Blue Fes 0754	F08
Verde Comodoro 0750	F09
Verde Kittami 0794	F11
Beige Arizona 0748	F12
Viola Orissa 0790	F13

### Pluto Electric Kits (PL)

Satin White	SWE
Satin Black	SBK

### Pandora Electric Kits (PA)

Black Plain Trim	BKP
White Plain Trim	WHP
Black with Stainless	SST
Steel Trim	

### Upright Light Kits (L)

Black Light	B
White Light	W
Red Light	R
Green Light	G

### Tube Light Kits (T)

Black Light	-
-------------	---

Notes: Walnut ply legs and laminate central strip is available as an SPT.

# channel work table

## /laminated tops

Channel work table with wire legs, laminate worktops and a central channel in fabric or metal.

Select leg finish, Pluto (80mm) or Pandora (128mm) holes, optional light holes, channel finishes and worktop finishes.

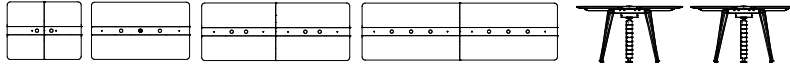
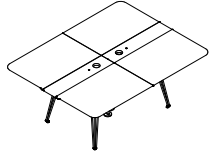

	ELECTRIC HOLES	LIGHT HOLES	CHANNEL MATERIAL	WORKTOP MATERIAL	WIDTH	DEPTH	HEIGHT
CWT1814W *** * * * * * * * *	2x Holes	2x holes	Fabric	Laminate	1800mm	1400mm	755mm
CWT2414W *** * * * * * * * *	3x Holes	2x holes	Fabric	Laminate	2400mm	1400mm	755mm
CWT3614W *** * * * * * * * *	4x Holes	4x holes	Fabric	Laminate	3600mm	1400mm	755mm
CWT4814W *** * * * * * * * *	6x Holes	4x holes	Fabric	Laminate	4800mm	1400mm	755mm
CWT1814W *** * * * * * * * *	2x Holes	2x holes	Steel	Laminate	1800mm	1400mm	755mm
CWT2414W *** * * * * * * * *	3x Holes	2x holes	Steel	Laminate	2400mm	1400mm	755mm
CWT3614W *** * * * * * * * *	4x Holes	4x holes	Steel	Laminate	3600mm	1400mm	755mm
CWT4814W *** * * * * * * * *	6x Holes	4x holes	Steel	Laminate	4800mm	1400mm	755mm

Channel work table with ply wood legs. Laminate worktops and a central channel in fabric or metal.

Select leg finish, Pluto (80mm) or Pandora (128mm) holes, optional light holes, channel finishes and worktop finishes.

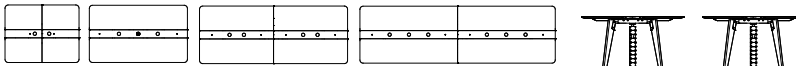
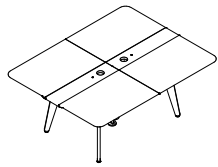

	ELECTRIC HOLES	LIGHT HOLES	CHANNEL MATERIAL	WORKTOP MATERIAL	WIDTH	DEPTH	HEIGHT
CWT1814P SAT ** * * * * * * *	2x Holes	2x holes	Fabric	Laminate	1800mm	1400mm	755mm
CWT2414P SAT ** * * * * * * *	3x Holes	2x holes	Fabric	Laminate	2400mm	1400mm	755mm
CWT3614P SAT ** * * * * * * *	4x Holes	4x holes	Fabric	Laminate	3600mm	1400mm	755mm
CWT4814P SAT ** * * * * * * *	6x Holes	4x holes	Fabric	Laminate	4800mm	1400mm	755mm
CWT1814P SAT ** * * * * * * *	2x Holes	2x holes	Steel	Laminate	1800mm	1400mm	755mm
CWT2414P SAT ** * * * * * * *	3x Holes	2x holes	Steel	Laminate	2400mm	1400mm	755mm
CWT3614P SAT ** * * * * * * *	4x Holes	4x holes	Steel	Laminate	3600mm	1400mm	755mm
CWT4814P SAT ** * * * * * * *	6x Holes	4x holes	Steel	Laminate	4800mm	1400mm	755mm

Channel poseur height work table with ply wood legs. Laminate worktops and a central channel in fabric or metal.

Select leg finish, Pluto (80mm) or Pandora (128mm) holes, optional light holes, channel finishes and worktop finishes.

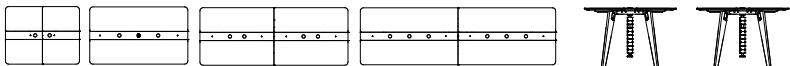
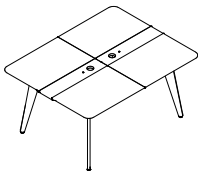



	ELECTRIC HOLES	LIGHT HOLES	CHANNEL MATERIAL	WORKTOP MATERIAL	WIDTH	DEPTH	HEIGHT
CWP1814P SAT ** * * * * * * *	2x Holes	2x Holes	Fabric	Laminate	1800mm	1400mm	1060mm
CWP2414P SAT ** * * * * * * *	3x Holes	2x Holes	Fabric	Laminate	2400mm	1400mm	1060mm
CWP3614P SAT ** * * * * * * *	4x Holes	4x Holes	Fabric	Laminate	3600mm	1400mm	1060mm
CWP4814P SAT ** * * * * * * *	6x Holes	4x Holes	Fabric	Laminate	4800mm	1400mm	1060mm
CWP1814P SAT ** * * * * * * *	2x Holes	2x holes	Steel	Laminate	1800mm	1400mm	1060mm
CWP2414P SAT ** * * * * * * *	3x Holes	2x holes	Steel	Laminate	2400mm	1400mm	1060mm
CWP3614P SAT ** * * * * * * *	4x Holes	4x holes	Steel	Laminate	3600mm	1400mm	1060mm
CWP4814P SAT ** * * * * * * *	6x Holes	4x holes	Steel	Laminate	4800mm	1400mm	1060mm

# /fenix tops

Channel work table with wire legs, Fenix® worktops and a central channel in fabric or metal.

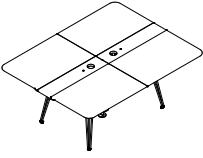
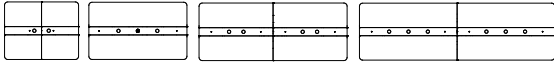

Select leg finish, Pluto (80mm) or Pandora (128mm) holes, optional light holes, channel finishes and worktop finishes.

	ELECTRIC HOLES	LIGHT HOLES	CHANNEL MATERIAL	WORKTOP MATERIAL	WIDTH	DEPTH	HEIGHT
CWT1814W **** * *****	2x Holes	2x holes	Fabric	Fenix®	1800mm	1400mm	755mm
CWT2414W **** * *****	3x Holes	2x holes	Fabric	Fenix®	2400mm	1400mm	755mm
CWT3614W **** * *****	4x Holes	4x holes	Fabric	Fenix®	3600mm	1400mm	755mm
CWT4814W **** * *****	6x Holes	4x holes	Fabric	Fenix®	4800mm	1400mm	755mm
CWT1814W **** * **** *	2x Holes	2x holes	Steel	Fenix®	1800mm	1400mm	755mm
CWT2414W **** * **** *	3x Holes	2x holes	Steel	Fenix®	2400mm	1400mm	755mm
CWT3614W **** * **** *	4x Holes	4x holes	Steel	Fenix®	3600mm	1400mm	755mm
CWT4814W **** * **** *	6x Holes	4x holes	Steel	Fenix®	4800mm	1400mm	755mm

Channel work table with ply wood legs and black steel connection. Fenix® worktops and a central channel in fabric or metal.

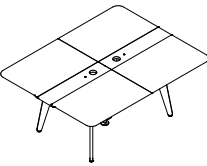
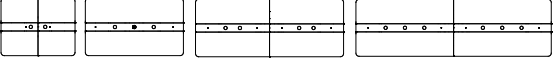

Select leg finish, Pluto (80mm) or Pandora (128mm) holes, optional light holes, channel finishes and worktop finishes.

	ELECTRIC HOLES	LIGHT HOLES	CHANNEL MATERIAL	WORKTOP MATERIAL	WIDTH	DEPTH	HEIGHT
CWT1814P SAT ** * **** *	2x Holes	2x Holes	Fabric	Fenix®	1800mm	1400mm	755mm
CWT2414P SAT ** * **** *	3x Holes	2x Holes	Fabric	Fenix®	2400mm	1400mm	755mm
CWT3614P SAT ** * **** *	4x Holes	4x Holes	Fabric	Fenix®	3600mm	1400mm	755mm
CWT4814P SAT ** * **** *	6x Holes	4x Holes	Fabric	Fenix®	4800mm	1400mm	755mm
CWT1814P SAT ** * *****	2x Holes	2x holes	Steel	Fenix®	1800mm	1400mm	755mm
CWT2414P SAT ** * *****	3x Holes	2x holes	Steel	Fenix®	2400mm	1400mm	755mm
CWT3614P SAT ** * *****	4x Holes	4x holes	Steel	Fenix®	3600mm	1400mm	755mm
CWT4814P SAT ** * *****	6x Holes	4x holes	Steel	Fenix®	4800mm	1400mm	755mm

Channel poseur height work table with ply wood legs and black steel connection. Fenix® worktops and a central channel in fabric or metal.

Select leg finish, Pluto (80mm) or Pandora (128mm) holes, optional light holes, channel finishes and worktop finishes.

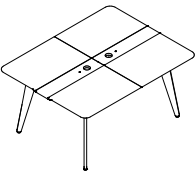
	ELECTRIC HOLES	LIGHT HOLES	CHANNEL MATERIAL	WORKTOP MATERIAL	WIDTH	DEPTH	HEIGHT
CWP1814P SAT ** * **** *	2x Holes	2x Holes	Fabric	Fenix®	1800mm	1400mm	1060mm
CWP2414P SAT ** * **** *	3x Holes	2x Holes	Fabric	Fenix®	2400mm	1400mm	1060mm
CWP3614P SAT ** * **** *	4x Holes	4x Holes	Fabric	Fenix®	3600mm	1400mm	1060mm
CWP4814P SAT ** * **** *	6x Holes	4x Holes	Fabric	Fenix®	4800mm	1400mm	1060mm
CWP1814P SAT ** * *****	2x Holes	2x holes	Steel	Fenix®	1800mm	1400mm	1060mm
CWP2414P SAT ** * *****	3x Holes	2x holes	Steel	Fenix®	2400mm	1400mm	1060mm
CWP3614P SAT ** * *****	4x Holes	4x holes	Steel	Fenix®	3600mm	1400mm	1060mm
CWP4814P SAT ** * *****	6x Holes	4x holes	Steel	Fenix®	4800mm	1400mm	1060mm



# /accessories

## Pluto Electrical Kit

Pluto with 2 power and a twin USB (1x type A, 1x type C). Includes connecting lead and 3m lead with UK plug.  
Please ensure PL is specified on your table.

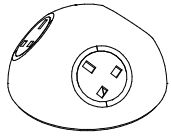

QTY/MODULES

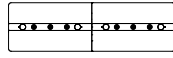

COMPATIBLE  
TABLE SIZE

CWT2PLU *** -3	2x Pluto Modules	1800mm
CWT3PLU *** -3	3x Pluto Modules	2400mm
CWT4PLU *** -3	4x Pluto Modules	3600mm
CWT6PLU *** -3	6x Pluto Modules	4800mm

## Pandora Electrical Kit

Pandora with 2 power and a twin USB (1x type A, 1x type C). Includes connecting lead and 3m lead with UK plug.  
Please ensure PA is specified on your table.

*4 leg tables (1800mm & 2400mm) tables require 1 floor sockets. 6 leg tables (3600mm & 4800mm) tables require 2 floor sockets*

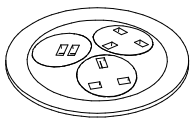

QTY/MODULES

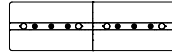

COMPATIBLE  
TABLE SIZE

CWT2PAN *** -3	2x Pandora Modules	1800mm
CWT3PAN *** -3	3x Pandora Modules	2400mm
CWT4PAN *** -3	4x Pandora Modules	3600mm
CWT6PAN *** -3	6x Pandora Modules	4800mm

## Light Kits

Please ensure light holes are specified on your table using code 'L'.

*All tables with a lighting kit specified require an additional floor socket*

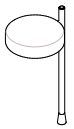

QTY/LIGHTS

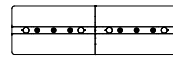

COMPATIBLE  
TABLE SIZE

CWT2LIGHT*-3	2x Lights	1800 & 2400mm
CWT4LIGHT*-3	4x Lights	3600 & 4800mm

## Tube Light Kits

Please ensure light holes are specified on your table using code 'T'.

*All tables with a lighting kit specified require an additional floor socket.*



QTY/  
LIGHTS



COMPATIBLE  
TABLE SIZE

CWTLIGHT18	1 Light & 3mt mains cable	1800mm
CWTLIGHT24	1 Light & 3mt mains cable	2400mm
CWTLIGHT36	2 Lights, 3mt mains cable & Splitter	3600mm
CWTLIGHT48	2 Lights, 3mt mains cable & Splitter	4800mm



# jot-up meet

## HOW TO SPECIFY JOT-UP MEET



TOP CODE  
(E.G: 'JUPMEET2412')



STEEL COLOUR  
(E.G: 'JWM')



TOP COLOUR  
(E.G: 'WHO')

For example, to specify a 2400mm (w) x 1200mm (d) x 610mm - 1260mm (h) height adjustable Jot-Up Meet with white frame, white top and oak edge, the code would be JUPMEET2412JWMWHO. All tables are supplied with two up-down control switches (mounted at opposite ends of the tables), integral cable tray and adjustable levellers. Please note, cable spines are not included as standard.

### Steel Finishes

Silver	JOM
White	JWM
Black	BLM

### Band 1 MFC Finishes

White	WHM
White/ Oak Edge	WHO
White/ Black Edge	WHB
Pale Grey	MOG
Dust Grey	DGM
Light Oak*	MOK*
Walnut*	MOW*

*\*Please note, we cannot guarantee continuity of these finishes.*

### Band 2 MFC Finishes

Cashmere Grey	MSC
Antique Rose	MAR
Reed Green	MRG
Denim Blue	MDB
Hamilton Oak	MHO
Nebraska Oak	MNO
Truffle Brown Oak	MDO
Natural Carini Walnut	MCW
Sevilla Ash	MSA
Chicago Concrete	MCC

# jot-up meet

## Jot-Up Meet Twin Column Sit/Stand Table.

Supplied with 2x up/down switches and integral cable tray.

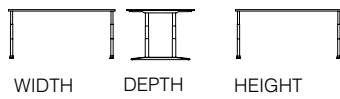
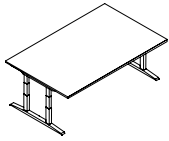

JUPMEET2012**** **	2000mm	1200mm	610- 1260mm
JUPMEET2412**** **	2400mm	1200mm	610 - 1260mm
JUPMEET2014**** **	2000mm	1400mm	610 - 1260mm
JUPMEET2414**** **	2400mm	1400mm	610 - 1260mm

## Jot-Up Meet Single Column Sit/Stand Table.

Supplied with 2x up/down switches and integral cable tray.

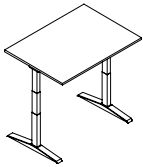

JUPMEET1608**** **	1600mm	800mm	610 - 1260mm
JUPMEET1809**** **	1800mm	900mm	610 - 1260mm
JUPMEET2010**** **	2000mm	1000mm	610 - 1260mm

## Jot-Up Lite Cable Spines.

Feeds cables from the cable tray to the floor.



COLOUR

JUPSPINEJWS	White
JUPSPINEJOS	Silver



# x-range

## HOW TO SPECIFY X-RANGE TABLES



TOP CODE  
(For example: 'XT06')



SHAPE  
(EG: 'C')

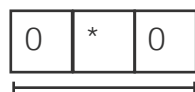

HEIGHT  
(For example: '050')



LEG FINISH  
(EG: 'B')



TOP COLOUR  
(For example: 'MOK')

For example, to specify a 600mm dia x 525mm high X-range coffee table with black staining and circular oak top, the code would be: XT06C050BMOK. All legs are made out of ash wood and stained to white, black, walnut or oak.

### Leg Finishes

Oak Staining	O
Black Staining	B
White Staining	W
Walnut Staining	N

### Top Shape

Circular	C
Square	S

### Band 1 MFC Finishes

White	WHM
White/ Oak Edge	WHO
White/ Black Edge	WHB
Pale Grey	MOG
Dust Grey	DGM
Light Oak*	MOK*
Walnut*	MOW*

### Band 2 MFC Finishes

Cashmere Grey	MSC
Antique Rose	MAR
Reed Green	MRG
Denim Blue	MDB
Hamilton Oak	MHO
Nebraska Oak	MNO
Truffle Brown Oak	MDO
Natural Carini Walnut	MCW
Sevilla Ash	MSA
Chicago Concrete	MCC

*\*Please note, we cannot guarantee continuity of these finishes.*

# x-range tables

## X-range circular table.

4 ash wood legs. 25mm MFC top as standard.

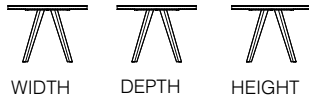

XT06C040 * ***	600mm	600mm	425mm
XT08C040 * ***	800mm	800mm	425mm
XT06C050 * ***	600mm	600mm	525mm
XT08C050 * ***	800mm	800mm	525mm

## X-range square table.

4 ash wood legs. 25mm MFC top as standard.

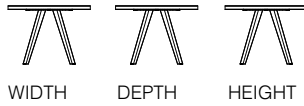
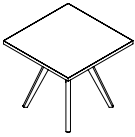

XT06S040 * ***	600mm	600mm	425mm
XT08S040 * ***	800mm	800mm	425mm
XT06S050 * ***	600mm	600mm	525mm
XT08S050 * ***	800mm	800mm	525mm



# hairpin

## HOW TO SPECIFY HAIRPIN TABLES

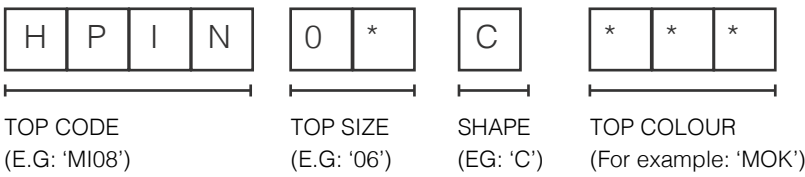

For example, to specify a 600mm dia top x 435mm high Hairpin coffee table with an oak circular top, the code would be: HPIN06CMOK.

Leg		Top Shapes		Band 1 MFC Finishes		Band 2 MFC Finishes	
Black	-	Circular	C	White	WHM	Cashmere Grey	MSC
		Square	S	White/ Oak Edge	WHO	Antique Rose	MAR
				White/ Black Edge	WHB	Reed Green	MRG
				Pale Grey	MOG	Denim Blue	MDB
				Dust Grey	DGM	Hamilton Oak	MHO
				Light Oak*	MOK*	Nebraska Oak	MNO
				Walnut*	MOW*	Truffle Brown Oak	MDO
						Natural Carini Walnut	MCW
						Sevilla Ash	MSA
						Chicago Concrete	MCC

*\*Please note, we cannot guarantee continuity of these finishes.*

# hairpin table

## Hairpin circular table.

Black hairpin coffee table with 3 legs.

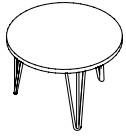

WIDTH



DEPTH



HEIGHT

HPIN06C \*\*\*

600mm

600mm

435mm

HPIN08C \*\*\*

800mm

800mm

435mm

## Hairpin square table.

Black hairpin coffee table with 4 legs.

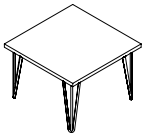

WIDTH



DEPTH



HEIGHT

HPIN06S \*\*\*

600mm

600mm

435mm

HPIN08S \*\*\*

800mm

800mm

435mm



office desks & screens







## homeworker desks

There are 3 homeworker desk options that can be sent directly to individual staff members at home. These include;

**Picola** (pictured above)

The Picola Homeworker desk is based on our most popular office desking range “Pico”. This home office desk can be constructed in minutes with minimal tools (Allen key provided). Finish all in white.

**Wooden Folding Homeworker Desk**

This high-quality home office desk requires no self-assembly – so no need for tools and complicated instructions to follow! Taking just a few seconds to get it ready for use thanks to the clever fold-up design. Once the working day is over or you need space back, simply fold down the table and stow it away. Add in an optional chair, monitor stand and laptop stand for the perfect home working setup.

# Picola Homeworker Desk

## Picola single desk.

Fixed top, self assembly. All white.



	WIDTH	DEPTH	HEIGHT
--	-------	-------	--------

PICOLA1006JWSWHM	1000mm	600mm	733mm
------------------	--------	-------	-------

PICOLA1206JWSWHM	1170mm	600mm	733mm
------------------	--------	-------	-------

# Wooden Folding Homeworker Desk

## Wooden Panel Folding Desk

White MFC.



	WIDTH	DEPTH	HEIGHT
--	-------	-------	--------

HW-FOLD1006WHM	1000mm	600mm	740mm
----------------	--------	-------	-------

HW-FOLD1206WHM	1200mm	600mm	740mm
----------------	--------	-------	-------



todd desks

## HOW TO SPECIFY TODD DESKING



CODE  
(For example: 'TOD1208')



FRAME  
(For example: 'STR')



FRAME COLOUR  
(For example: 'JWM')



TOP COLOUR  
(For example: 'MOK')

Todd desks are specified as either a single standalone desk, or as starter, optional middle and end modules to create a side-to-side desks.

For example, to specify a 1200mm (w) x 800mm (d) x 730mm (h) side-to-side Todd desk with a white steel frame and oak MFC top (pictured above) the codes would be TOD1208STRJWSMOK and TOD1208ENDJWMMOK.

*Please note, all Todd desks are complete with modesty panel and cable trays.*

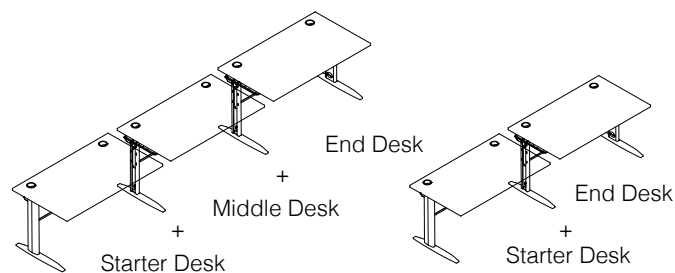

### Steel Finishes

Black, Matt	BLM	Patina Green, Matt	GAM
Graphite Grey, Matt	GGM	Pale Green, Matt	GCM
Jot Silver, Matt	JOM	Sapphire Blue, Matt	USM
Pale Grey, Matt	PGM	Violet Blue, Matt	UVM
White, Matt	JWM	Distant Blue, Matt	UDM
Pale Brown, Matt	BPM	Pastel Blue, Matt	UPM
Grey Beige, Matt	BGM	Purple Red, Matt	RPM
Beige, Matt	BBM	Red Violet, Matt	RYM
Light Ivory, Matt	BIM	Orient Red, Matt	ROM
Olive Green, Matt	GOM	Beige Red, Matt	RBM
Fern Green, Matt	GFM	Tomato Red, Matt	RTM
Reed Green, Matt	GRM	Salmon Pink, Matt	PSM
Black Green, Matt	GBM	Yellow Orange, Matt	OYM
Pine Green, Matt	GPM	Broom Yellow, Matt	YBM

### Band 1 MFC Finishes

White	WHM
White/ Oak Edge	WHO
White/ Black Edge	WHB
Pale Grey	MOG
Dust Grey	DGM
Light Oak*	MOK*
Walnut*	MOW*

*\*Please note, we cannot guarantee continuity of these finishes.*

### Band 2 MFC Finishes

Cashmere Grey	MSC
Antique Rose	MAR
Reed Green	MRG
Denim Blue	MDB
Hamilton Oak	MHO
Nebraska Oak	MNO
Truffle Brown Oak	MDO
Natural Carini Walnut	MCW
Sevilla Ash	MSA
Chicago Concrete	MCC

# todd desks

## Todd single office desk with modesty panel and cable tray.

Standalone desk.

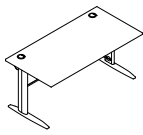

	WIDTH	DEPTH	HEIGHT
TOD0808*****	800mm	800mm	730mm
TOD1008*****	1000mm	800mm	730mm
TOD1208*****	1200mm	800mm	730mm
TOD1408*****	1400mm	800mm	730mm
TOD1608*****	1600mm	800mm	730mm
TOD1808*****	1800mm	800mm	730mm

## Todd starter office desk with modesty panel and cable tray.

This desk requires a Middle/End or End desk to be completed.

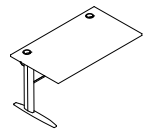

	WIDTH	DEPTH	HEIGHT
TOD0808STR*****	800mm	800mm	730mm
TOD1008STR*****	1000mm	800mm	730mm
TOD1208STR*****	1200mm	800mm	730mm
TOD1408STR*****	1400mm	800mm	730mm
TOD1608STR*****	1600mm	800mm	730mm
TOD1808STR*****	1800mm	800mm	730mm

## Todd mid office desk with modesty panel and cable tray.

This desk requires a Starter and End desk to be completed.

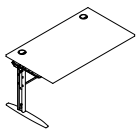

	WIDTH	DEPTH	HEIGHT
TOD0808MID*****	800mm	800mm	730mm
TOD1008MID*****	1000mm	800mm	730mm
TOD1208MID*****	1200mm	800mm	730mm
TOD1408MID*****	1400mm	800mm	730mm
TOD1608MID*****	1600mm	800mm	730mm
TOD1808MID*****	1800mm	800mm	730mm

## Todd end office desk with modesty panel and cable tray.

This desk requires a Starter or Starter/End desk to be completed.

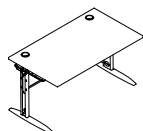

	WIDTH	DEPTH	HEIGHT
TOD0808END*****	800mm	800mm	730mm
TOD1008END*****	1000mm	800mm	730mm
TOD1208END*****	1200mm	800mm	730mm
TOD1408END*****	1400mm	800mm	730mm
TOD1608END*****	1600mm	800mm	730mm
TOD1808END*****	1800mm	800mm	730mm

## Todd Screen Brackets (Pair).

TODSCRBRKT\*\*\* Steel Finishes



# meira desks

## HOW TO SPECIFY MEIRA DESKING



CODE  
(E.G: 'MDESK1416')

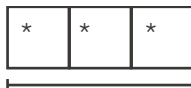

FRAME COLOUR  
(E.G: 'JWM')

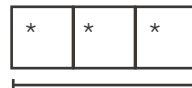

MFC FINISH  
(E.G: 'WHO')

For example, to specify a 4 person back-to-back 1400mm (w) x 1650mm (d) x 740mm (h) desk, white MFC top with oak edging and white goalpost frame the code would be MDESK1416JWMWHO and MEXT1416JWMWHO.

### Finishes

Black, Matt	BLM	Patina Green, Matt	GAM
Graphite Grey, Matt	GGM	Pale Green, Matt	GCM
Jot Silver, Matt	JOM	Sapphire Blue, Matt	USM
Pale Grey, Matt	PGM	Violet Blue, Matt	UVM
White, Matt	JWM	Distant Blue, Matt	UDM
Pale Brown, Matt	BPM	Pastel Blue, Matt	UPM
Grey Beige, Matt	BGM	Purple Red, Matt	RPM
Beige, Matt	BBM	Red Violet, Matt	RYM
Light Ivory, Matt	BIM	Orient Red, Matt	ROM
Olive Green, Matt	GOM	Beige Red, Matt	RBM
Fern Green, Matt	GFM	Tomato Red, Matt	RTM
Reed Green, Matt	GRM	Salmon Pink, Matt	PSM
Black Green, Matt	GBM	Yellow Orange, Matt	OYM
Pine Green, Matt	GPM	Broom Yellow, Matt	YBM

### Band 1 MFC Finishes

White	WHM
White/ Oak Edge	WHO
White/ Black Edge	WHB
Pale Grey	MOG
Dust Grey	DGM
Light Oak*	MOK*
Walnut*	MOW*

*\*Please note, we cannot guarantee continuity of these finishes.*

### Band 2 MFC Finishes

Cashmere Grey	MSC
Antique Rose	MAR
Reed Green	MRG
Denim Blue	MDB
Hamilton Oak	MHO
Nebraska Oak	MNO
Truffle Brown Oak	MDO
Natural Carini Walnut	MCW
Sevilla Ash	MSA
Chicago Concrete	MCC

*Please note, 495h mobile pedestals will pass under the cable tray. 597h pedestals will fit under the desk by need to sit in front of the cable tray*

# meira

## /single desk

Single Rectangular Desk with Modesty Panel.

Goalpost leg, sliding top. Please order a cable tray separately.

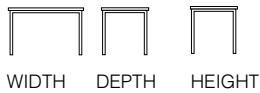
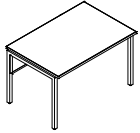

	WIDTH	DEPTH	HEIGHT
MSINGLE1208 *** **	1195mm	800mm	740mm
MSINGLE1408 *** **	1395mm	800mm	740mm
MSINGLE1608 *** **	1595mm	800mm	740mm
MSINGLE16508 *** **	1650mm	800mm	740mm

## /side-to-side desks

Side-to-Side Rectangular Starter Desk.

Goalpost leg, sliding top.

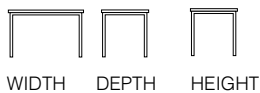
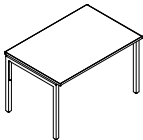

	WIDTH	DEPTH	HEIGHT
MDESK1208 *** **	1195mm	800mm	740mm
MDESK1408 *** **	1395mm	800mm	740mm
MDESK1608 *** **	1595mm	800mm	740mm

Side-to-Side Rectangular Extension Desk.

Goalpost leg, sliding top.

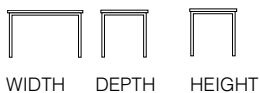
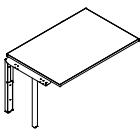

	WIDTH	DEPTH	HEIGHT
MEXT1208 *** **	1195mm	800mm	740mm
MEXT1408 *** **	1395mm	800mm	740mm
MEXT1608 *** **	1595mm	800mm	740mm

## /back-to-back desks

Back-to-Back Rectangular Starter Desk.

Goalpost leg, sliding top.

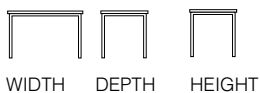
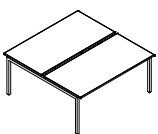

	WIDTH	DEPTH	HEIGHT
MDESK1216 *** **	1195mm	1650mm	740mm
MDESK1416 *** **	1395mm	1650mm	740mm
MDESK1616 *** **	1595mm	1650mm	740mm

**Back-to-Back Rectangular Extension Desk.**  
Goalpost leg, sliding top.

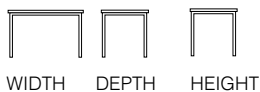
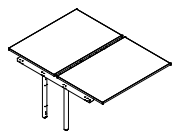

	WIDTH	DEPTH	HEIGHT
MEXT1216 *** **	1195mm	1650mm	740mm
MEXT1416 *** **	1395mm	1650mm	740mm
MEXT1616 *** **	1595mm	1650mm	740mm

## /accessories

**Single Sided Cable Tray**

For a single and side-to-side desks and extensions only.

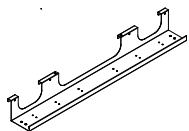

	WIDTH	DEPTH	HEIGHT
MSSTRAY1200 ***	920mm	130mm	125mm
MSSTRAY1400 ***	1120mm	130mm	125mm
MSSTRAY1600 ***	1320mm	130mm	125mm

**Back-to-Back Cable Tray**

For back-to-back desks and extensions only.

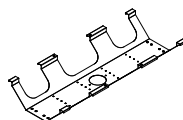

	WIDTH	DEPTH	HEIGHT
MBBTRAY1200 ***	920mm	360mm	130mm
MBBTRAY1400 ***	1120mm	360mm	130mm
MBBTRAY1600 ***	1320mm	360mm	130mm

**Single Modesty Panel**

For side-to-side desks and extensions only. Non-handed.

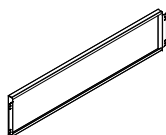

	WIDTH	DEPTH	HEIGHT
MMOD1200 ***	1116mm	30mm	300mm
MMOD1400 ***	1316mm	30mm	300mm
MMOD1600 ***	1516mm	30mm	300mm

**Cable Covers**

For side-to-side and back-to-back extensions only.

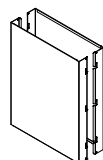

	WIDTH	DEPTH	HEIGHT
MSSCOVER***	-	-	-
MBBCOVER***	-	-	-
-	-	-	-

**Single Screen Bracket**

For single and side-to-side desks and extensions only.  
Not suitable for Dolly screens.

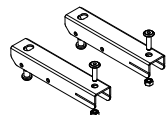

	WIDTH	DEPTH	HEIGHT
MSSSCRBRKT***	-	-	-

**Back-to-Back Screen Bracket**

For back-to-back desks and extensions only.  
Not suitable for Dolly screens.

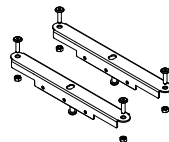

	WIDTH	DEPTH	HEIGHT
MBBSCRBRKT ***	-	-	-







# pico desks

## HOW TO SPECIFY PICO DESKING

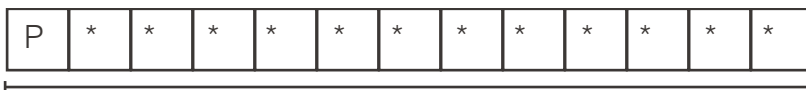

CODE  
(E.G: 'PSTDESK1416' shown above)

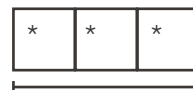

FRAME COLOUR  
(E.G: 'JWM')

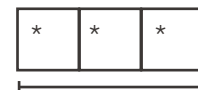

MFC FINISH  
(E.G: 'WHO')

For example, to specify a single 1400mm (w) x 800mm (d) x 740mm (h) sliding top desk with a modesty panel, white MFC top with oak edging and white goalpost frame the code would be PSTDESK1416JWMWHO. When ordering a desk consider additional elements such as a screen, screen accessories and cable management.

### Finishes

Black, Matt	BLM	Sapphire Blue, Matt	USM
Graphite Grey, Matt	GGM	Violet Blue, Matt	UVM
Jot Silver, Matt	JOM	Distant Blue, Matt	UDM
Pale Grey, Matt	PGM	Pastel Blue, Matt	UPM
White, Matt	JWM	Purple Red, Matt	RPM
Pale Brown, Matt	BPM	Red Violet, Matt	RYM
Grey Beige, Matt	BGM	Orient Red, Matt	ROM
Beige, Matt	BBM	Beige Red, Matt	RBM
Light Ivory, Matt	BIM	Tomato Red, Matt	RTM
Olive Green, Matt	GOM	Salmon Pink, Matt	PSM
Fern Green, Matt	GFM	Yellow Orange, Matt	OYM
Reed Green, Matt	GRM	Broom Yellow, Matt	YBM
Black Green, Matt	GBM		
Pine Green, Matt	GPM		
Patina Green, Matt	GAM		
Pale Green, Matt	GCM		

### Band 1 MFC Finishes

White	WHM
White/ Oak Edge	WHO
White/ Black Edge	WHB
Pale Grey	MOG
Dust Grey	DGM
Light Oak*	MOK*
Walnut*	MOW*

*\*Please note, we cannot guarantee continuity of these finishes.*

### Band 2 MFC Finishes

Cashmere Grey	MSC
Antique Rose	MAR
Reed Green	MRG
Denim Blue	MDB
Hamilton Oak	MHO
Nebraska Oak	MNO
Truffle Brown Oak	MDO
Natural Carini Walnut	MCW
Sevilla Ash	MSA
Chicago Concrete	MCC

# pico single desk /goalpost leg

Note: Cable trays, screens and screen support rails (PUNISUPT) / screen clamps are not included.

## Rectangular Desk with Modesty Panel. Goalpost Leg. Fixed Top.

To attach a screen, please use a screen support rail (the rail turns the desk into a sliding top desk with screen).

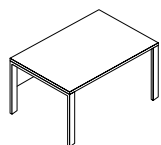

	WIDTH	DEPTH	HEIGHT
PFTSINGLE0808 *** **	800mm	800mm	740mm
PFTSINGLE1008 *** **	1000mm	800mm	740mm
PFTSINGLE1208 *** **	1200mm	800mm	740mm
PFTSINGLE1408 *** **	1400mm	800mm	740mm
PFTSINGLE1608 *** **	1600mm	800mm	740mm
PFTSINGLE16508 *** **	1650mm	800mm	740mm
PFTSINGLE1808 *** **	1800mm	800mm	740mm

## Rectangular Desk with Modesty Panel. Goalpost Leg. Fixed Top.

To attach a screen, please use a screen clamp.

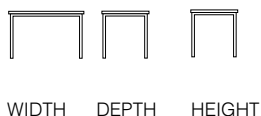
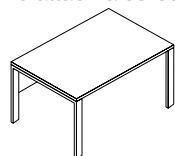

	WIDTH	DEPTH	HEIGHT
PFTSINGLE0806 *** **	800mm	600mm	740mm
PFTSINGLE1006 *** **	1000mm	600mm	740mm
PFTSINGLE1206 *** **	1200mm	600mm	740mm
PFTSINGLE1406 *** **	1400mm	600mm	740mm
PFTSINGLE1606 *** **	1600mm	600mm	740mm
PFTSINGLE1806 *** **	1800mm	600mm	740mm

## Rectangular Desk with Modesty Panel. Goalpost Leg. Sliding Top

Not compatible with screens, please see above desk.

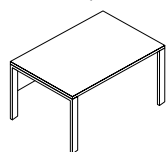

	WIDTH	DEPTH	HEIGHT
PSTSINGLE0808 *** **	800mm	800mm	740mm
PSTSINGLE1008 *** **	1000mm	800mm	740mm
PSTSINGLE1208 *** **	1200mm	800mm	740mm
PSTSINGLE1408 *** **	1400mm	800mm	740mm
PSTSINGLE1608 *** **	1600mm	800mm	740mm
PSTSINGLE16508 *** **	1650mm	800mm	740mm
PSTSINGLE1808 *** **	1800mm	800mm	740mm

**Workstation Desk with Modesty Panel. Goalpost Leg. Fixed Top**

Left handed (LH) or right handed (RH). To attach a screen, please use a screen support rail ( the rail turns the desk into a sliding top desk with screen).

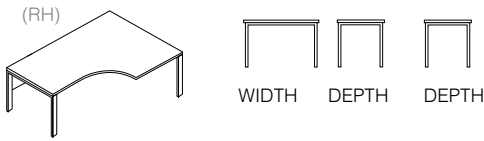

PFTWSLH1612 *** **	1600mm	1200mm	8-6
PFTWSLH1812 *** **	1800mm	1200mm	8-6
PFTWSRH1612 *** **	1600mm	1200mm	8-6
PFTWSRH1812 *** **	1800mm	1200mm	8-6

**Workstation Desk with Modesty Panel. Goalpost Leg. Sliding Top**

Left handed (LH) or right handed (RH). Not compatible with screens, please see fixed top desk.

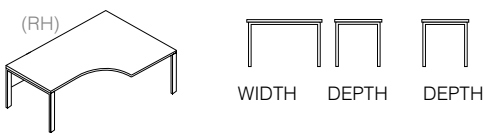

PSTWSLH1612 *** **	1600mm	1200mm	8-6
PSTWSLH1812 *** **	1800mm	1200mm	8-6
PSTWSRH1612 *** **	1600mm	1200mm	8-6
PSTWSRH1812 *** **	1800mm	1200mm	8-6

# /A-frame leg

Note: Suspended modesty panels are available for A frame single desks, but are not included. Cable trays, screens and screen support rails (PUNISUPT)/ screen clamps are not included.

**Rectangular Desking. A-Frame Leg. Fixed Top.**

To attach a screen, please use a screen support rail. (the rail turns the desk into a sliding top desk with screen).

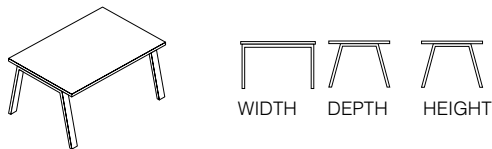

PAFTDESK0808*** **	800mm	800mm	740mm
PAFTDESK1008*** **	1000mm	800mm	740mm
PAFTDESK1208*** **	1200mm	800mm	740mm
PAFTDESK1408*** **	1400mm	800mm	740mm
PAFTDESK1608*** **	1600mm	800mm	740mm
PAFTDESK1808*** **	1800mm	800mm	740mm

**Rectangular Desking. A-Frame Leg. Fixed Top.**

To attach a screen, please use a screen clamp.

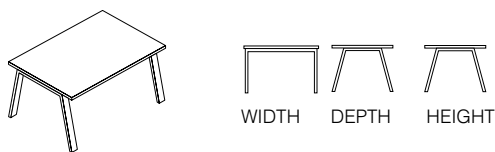

PAFTDESK0806*** **	800mm	600mm	740mm
PAFTDESK1006*** **	1000mm	600mm	740mm
PAFTDESK1206*** **	1200mm	600mm	740mm
PAFTDESK1406*** **	1400mm	600mm	740mm
PAFTDESK1606*** **	1600mm	600mm	740mm
PAFTDESK1806*** **	1800mm	600mm	740mm

**Rectangular Desking. A-Frame Leg. Sliding Top.**

Not compatible with screens, please see above desk.

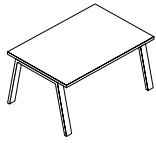

WIDTH DEPTH HEIGHT

PASTDESK0808 *** **	800mm	800mm	740mm
PASTDESK1008 *** **	1000mm	800mm	740mm
PASTDESK1208 *** **	1200mm	800mm	740mm
PASTDESK1408 *** **	1400mm	800mm	740mm
PASTDESK1608 *** **	1600mm	800mm	740mm
PASTDESK1808 *** **	1800mm	800mm	740mm

**Workstation Desk with Modesty Panel. A-Frame Leg. Fixed Top**

Left handed (LH) or right handed (RH). To attach a screen, please use a screen support rail (the rail turns the desk into a sliding top desk with screen).

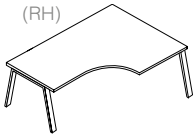

WIDTH DEPTH DEPTH

PAFTWSLH1612 *** **	1600mm	1200mm	8-6
PAFTWSLH1812 *** **	1800mm	1200mm	8-6
PAFTWSRH1612 *** **	1600mm	1200mm	8-6
PAFTWSRH1812 *** **	1800mm	1200mm	8-6

**Workstation Desk with Modesty Panel. A-Frame Leg. Sliding Top**

Left handed (LH) or right handed (RH). Not compatible with screens, please see fixed top desk.

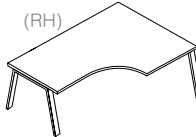

WIDTH DEPTH DEPTH

PASTWSLH1612 *** **	1600mm	1200mm	8-6
PASTWSLH1812 *** **	1800mm	1200mm	8-6
PASTWSRH1612 *** **	1600mm	1200mm	8-6
PASTWSRH1812 *** **	1800mm	1200mm	8-6

# /rectangular loop leg

Note: Cable trays, screens and screen support rails (PUNISUPT)/ screen clamps are not included.

**Rectangular Desk with Modesty Panel. Rectangular Loop Leg. Fixed Top.**

To attach a screen, please use a screen support rail (the rail turns the desk into a sliding top desk with screen).

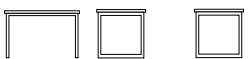
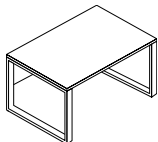

WIDTH DEPTH HEIGHT

PRFTS0808*** **	800mm	800mm	740mm
PRFTS1008*** **	1000mm	800mm	740mm
PRFTS1208*** **	1200mm	800mm	740mm
PRFTS1408*** **	1400mm	800mm	740mm
PRFTS1608*** **	1600mm	800mm	740mm
PRFTS1658*** **	1650mm	800mm	740mm
PRFTS1808*** **	1800mm	800mm	740mm

**Rectangular Desk with Modesty Panel. Rectangular Loop Leg. Fixed Top.**

To attach a screen, please use a screen clamp.

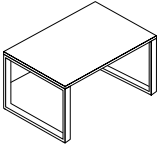

	WIDTH	DEPTH	HEIGHT
PRFTS0806*** **	800mm	600mm	740mm
PRFTS1006*** **	1000mm	600mm	740mm
PRFTS1206*** **	1200mm	600mm	740mm
PRFTS1406*** **	1400mm	600mm	740mm
PRFTS1606*** **	1600mm	600mm	740mm
PRFTS1806*** **	1800mm	600mm	740mm

**Rectangular Desk with Modesty Panel. Rectangular Loop Leg. Sliding Top.**

Not compatible with screens, please see above desk.

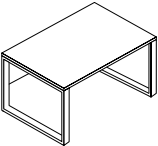

	WIDTH	DEPTH	HEIGHT
PRSTS0808*** **	800mm	800mm	740mm
PRSTS1008*** **	1000mm	800mm	740mm
PRSTS1208*** **	1200mm	800mm	740mm
PRSTS1408*** **	1400mm	800mm	740mm
PRSTS1608*** **	1600mm	800mm	740mm
PRSTS1658*** **	1650mm	800mm	740mm
PRSTS1808*** **	1800mm	800mm	740mm

**Workstation Desk with Modesty Panel. Rectangular Loop Leg. Fixed Top.**

Left handed (LH) or right handed (RH). To attach a screen, please use a screen support rail (the rail turns the desk into a sliding top desk with screen).

(RH)

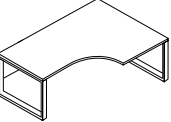

	WIDTH	DEPTH	DEPTH
PRFTWSLH1612*** **	1600mm	1200mm	8-6
PRFTWSLH1812*** **	1800mm	1200mm	8-6
PRFTWSRH1612*** **	1600mm	1200mm	8-6
PRFTWSRH1812*** **	1800mm	1200mm	8-6

**Workstation Desk with Modesty Panel. Rectangular Loop Leg. Sliding Top.**

Left handed (LH) or right handed (RH). Not compatible with screens, please see fixed top desk.

(RH)

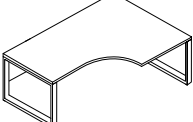

	WIDTH	DEPTH	DEPTH
PRSTWSLH1612*** **	1600mm	1200mm	8-6
PRSTWSLH1812*** **	1800mm	1200mm	8-6
PRSTWSRH1612*** **	1600mm	1200mm	8-6
PRSTWSRH1812*** **	1800mm	1200mm	8-6

# pico side-to-side desk /goalpost leg

Note: Modesty panels are available for all side-to-side desks but are not included.

## Rectangular Starter Bench Desk. Goalpost Leg. Fixed Top

To attach a screen, please use a screen support rail (the rail turns the desk into a sliding top desk with screen).

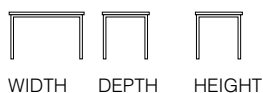
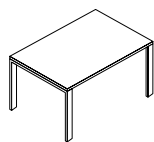

	WIDTH	DEPTH	HEIGHT
PFTDESK0808 *** **	800mm	800mm	740mm
PFTDESK1008 *** **	1000mm	800mm	740mm
PFTDESK1208 *** **	1200mm	800mm	740mm
PFTDESK1408 *** **	1400mm	800mm	740mm
PFTDESK1608 *** **	1600mm	800mm	740mm
PFTDESK1808 *** **	1800mm	800mm	740mm

## Rectangular Starter Bench Desk. Goalpost Leg. Fixed Top

To attach a screen, please use a screen clamp.

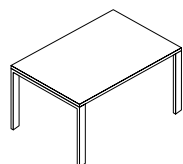

	WIDTH	DEPTH	HEIGHT
PFTDESK0806 *** **	800mm	600mm	740mm
PFTDESK1006 *** **	1000mm	600mm	740mm
PFTDESK1206 *** **	1200mm	600mm	740mm
PFTDESK1406 *** **	1400mm	600mm	740mm
PFTDESK1606 *** **	1600mm	600mm	740mm
PFTDESK1806 *** **	1800mm	600mm	740mm

## Rectangular Starter Bench Desk. Goalpost Leg. Sliding Top

Not compatible with screens, please see above desk.

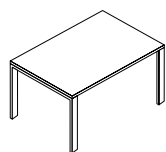

	WIDTH	DEPTH	HEIGHT
PSTDESK0808 *** **	800mm	800mm	740mm
PSTDESK1008 *** **	1000mm	800mm	740mm
PSTDESK1208 *** **	1200mm	800mm	740mm
PSTDESK1408 *** **	1400mm	800mm	740mm
PSTDESK1608 *** **	1600mm	800mm	740mm
PSTDESK1808 *** **	1800mm	800mm	740mm

# /A-frame leg

## Rectangular Starter Bench Desk. A-Frame Leg. Fixed Top

To attach a screen, please use a screen support rail (the rail turns the desk into a sliding top desk with screen).

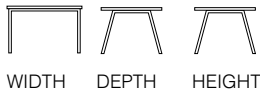
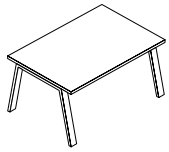

	WIDTH	DEPTH	HEIGHT
PAFTDESK0808*** **	800mm	800mm	740mm
PAFTDESK1008*** **	1000mm	800mm	740mm
PAFTDESK1208*** **	1200mm	800mm	740mm
PAFTDESK1408*** **	1400mm	800mm	740mm
PAFTDESK1608*** **	1600mm	800mm	740mm
PAFTDESK1808*** **	1800mm	800mm	740mm

## Rectangular Starter Bench Desk. A-Frame Leg. Fixed Top

To attach a screen, please use a screen clamp.

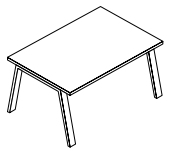

	WIDTH	DEPTH	HEIGHT
PAFTDESK0806*** **	800mm	600mm	740mm
PAFTDESK1006*** **	1000mm	600mm	740mm
PAFTDESK1206*** **	1200mm	600mm	740mm
PAFTDESK1406*** **	1400mm	600mm	740mm
PAFTDESK1606*** **	1600mm	600mm	740mm
PAFTDESK1806*** **	1800mm	600mm	740mm

## Rectangular Starter Bench Desk. A-Frame Leg. Sliding Top

Not compatible with screens, please see fixed top desk.

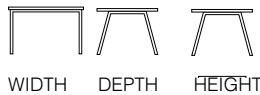
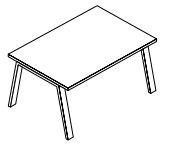

	WIDTH	DEPTH	HEIGHT
PASTDESK0808 *** **	800mm	800mm	740mm
PASTDESK1008 *** **	1000mm	800mm	740mm
PASTDESK1208 *** **	1200mm	800mm	740mm
PASTDESK1408 *** **	1400mm	800mm	740mm
PASTDESK1608 *** **	1600mm	800mm	740mm
PASTDESK1808 *** **	1800mm	800mm	740mm



# /rectangular loop leg

## Rectangular Starter Bench Desk. Rectangular Loop Leg. Fixed Top.

To attach a screen, please use a screen support rail (the rail turns the desk into a sliding top desk with screen).

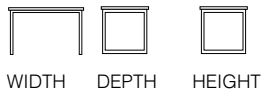
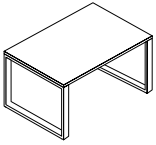

	WIDTH	DEPTH	HEIGHT
PRFTDESK0808*** **	800mm	800mm	740mm
PRFTDESK1008*** **	1000mm	800mm	740mm
PRFTDESK1208*** **	1200mm	800mm	740mm
PRFTDESK1408*** **	1400mm	800mm	740mm
PRFTDESK1608*** **	1600mm	800mm	740mm
PRFTDESK1808*** **	1800mm	800mm	740mm

## Rectangular Starter Bench Desk. Rectangular Loop Leg. Fixed Top.

To attach a screen, please use a screen clamp.

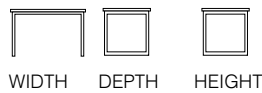
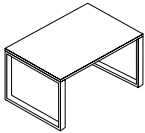

	WIDTH	DEPTH	HEIGHT
PRFTDESK0806*** **	800mm	600mm	740mm
PRFTDESK1006*** **	1000mm	600mm	740mm
PRFTDESK1206*** **	1200mm	600mm	740mm
PRFTDESK1406*** **	1400mm	600mm	740mm
PRFTDESK1606*** **	1600mm	600mm	740mm
PRFTDESK1806*** **	1800mm	600mm	740mm

## Rectangular Starter Bench Desk. Rectangular Loop Leg. Sliding Top.

Not compatible with screens, please see above desk.

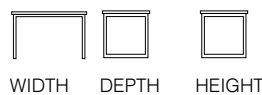
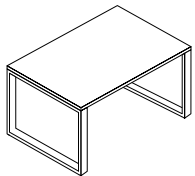

	WIDTH	DEPTH	HEIGHT
PRSTDESK0808*** **	800mm	800mm	740mm
PRSTDESK1008*** **	1000mm	800mm	740mm
PRSTDESK1208*** **	1200mm	800mm	740mm
PRSTDESK1408*** **	1400mm	800mm	740mm
PRSTDESK1608*** **	1600mm	800mm	740mm
PRSTDESK1808*** **	1800mm	800mm	740mm

# pico side-to-side desk extensions /universal frame

Note: Modesty panels are available, but are not included.

## Rectangular Side-to-Side Extension Bench Desk. Fixed Top.

To attach a screen, please use a screen support rail (the rail turns the desk into a sliding top desk with screen).

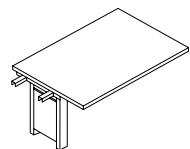

WIDTH DEPTH HEIGHT

PFTEXT0808*** **	800mm	800mm	740mm
PFTEXT1008*** **	1000mm	800mm	740mm
PFTEXT1208*** **	1200mm	800mm	740mm
PFTEXT1408*** **	1400mm	800mm	740mm
PFTEXT1608*** **	1600mm	800mm	740mm
PFTEXT1808*** **	1800mm	800mm	740mm

## Rectangular Side-to-Side Extension Bench Desk. Fixed Top

To attach a screen, please use a screen clamp.

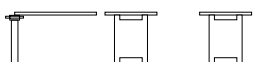
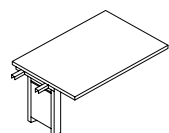

WIDTH DEPTH HEIGHT

PFTEXT0806*** **	800mm	600mm	740mm
PFTEXT1006*** **	1000mm	600mm	740mm
PFTEXT1206*** **	1200mm	600mm	740mm
PFTEXT1406*** **	1400mm	600mm	740mm
PFTEXT1606*** **	1600mm	600mm	740mm
PFTEXT1806*** **	1800mm	600mm	740mm

## Rectangular Side-to-Side Extension Bench Desks. Sliding Top

Not compatible with screens, please see above desk.

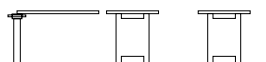
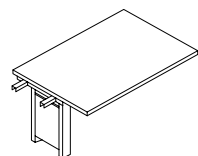

WIDTH DEPTH HEIGHT

PSTEXT0808*** **	800mm	800mm	740mm
PSTEXT1008*** **	1000mm	800mm	740mm
PSTEXT1208*** **	1200mm	800mm	740mm
PSTEXT1408*** **	1400mm	800mm	740mm
PSTEXT1608*** **	1600mm	800mm	740mm
PSTEXT1808*** **	1800mm	800mm	740mm

# pico back-to-back desk /goalpost leg

Note: Screens, cable trays and infill tubes are not included.

## Rectangular Back-to-Back Starter Bench. Goalpost Frame. Sliding Top.

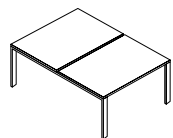

WIDTH DEPTH HEIGHT

PSTDESK0816*** **	800mm	1650mm	740mm
PSTDESK1016 *** **	1000mm	1650mm	740mm
PSTDESK1216 *** **	1200mm	1650mm	740mm
PSTDESK1416 *** **	1400mm	1650mm	740mm
PSTDESK1616 *** **	1600mm	1650mm	740mm
PSTDESK1816 *** **	1800mm	1650mm	740mm

## Rectangular Back-to-Back Starter Bench. Goalpost Frame. Sliding Top.

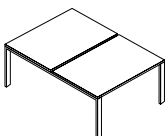

WIDTH DEPTH HEIGHT

PSTDESK0812*** **	800mm	1250mm	740mm
PSTDESK1012 *** **	1000mm	1250mm	740mm
PSTDESK1212 *** **	1200mm	1250mm	740mm
PSTDESK1412 *** **	1400mm	1250mm	740mm
PSTDESK1612 *** **	1600mm	1250mm	740mm
PSTDESK1812 *** **	1800mm	1250mm	740mm

# /A-frame leg

## Rectangular Back-to-Back Starter Bench. A-Frame Leg. Sliding Top

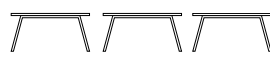
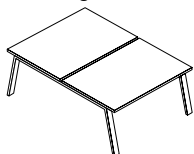

WIDTH DEPTH HEIGHT

PASTDESK0816*** **	800mm	1650mm	740mm
PASTDESK1016 *** **	1000mm	1650mm	740mm
PASTDESK1216 *** **	1200mm	1650mm	740mm
PASTDESK1416 *** **	1400mm	1650mm	740mm
PASTDESK1616 *** **	1600mm	1650mm	740mm
PASTDESK1816 *** **	1800mm	1650mm	740mm

## Rectangular Back-to-Back Starter Bench. A-Frame Leg. Sliding Top

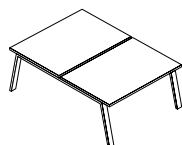

WIDTH DEPTH HEIGHT

PASTDESK0812*** **	800mm	1250mm	740mm
PASTDESK1012 *** **	1000mm	1250mm	740mm
PASTDESK1212 *** **	1200mm	1250mm	740mm
PASTDESK1412 *** **	1400mm	1250mm	740mm
PASTDESK1612 *** **	1600mm	1250mm	740mm
PASTDESK1812 *** **	1800mm	1250mm	740mm

# /rectangular loop leg

Rectangular Back-to-Back Starter Bench. Rectangular Loop Leg. Sliding Top.

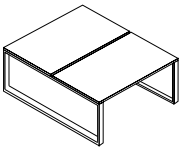

	WIDTH	DEPTH	HEIGHT
PRSTDESK0816*** **	800mm	1650mm	740mm
PRSTDESK1016 *** **	1000mm	1650mm	740mm
PRSTDESK1216 *** **	1200mm	1650mm	740mm
PRSTDESK1416 *** **	1400mm	1650mm	740mm
PRSTDESK1616 *** **	1600mm	1650mm	740mm
PRSTDESK1816 *** **	1800mm	1650mm	740mm

Rectangular Back-to-Back Starter Bench. Rectangular Loop Leg. Sliding Top.

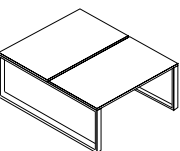

	WIDTH	DEPTH	HEIGHT
PRSTDESK0812*** **	800mm	1250mm	740mm
PRSTDESK1012 *** **	1000mm	1250mm	740mm
PRSTDESK1212 *** **	1200mm	1250mm	740mm
PRSTDESK1412 *** **	1400mm	1250mm	740mm
PRSTDESK1612 *** **	1600mm	1250mm	740mm
PRSTDESK1812 *** **	1800mm	1250mm	740mm

# pico back-to-back desk extensions /universal frame

Rectangular Back-to-Back Extension Bench. Sliding Top.

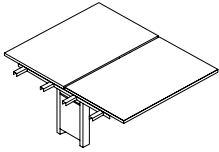

	WIDTH	DEPTH	HEIGHT
PSTEXCT0816*** **	800mm	1650mm	740mm
PSTEXCT1016*** **	1000mm	1650mm	740mm
PSTEXCT1216*** **	1200mm	1650mm	740mm
PSTEXCT1416*** **	1400mm	1650mm	740mm
PSTEXCT1616*** **	1600mm	1650mm	740mm
PSTEXCT1816*** **	1800mm	1650mm	740mm

Rectangular Back-to-Back Extension Bench. Sliding Top.

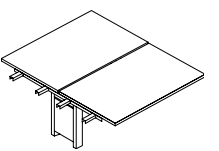

	WIDTH	DEPTH	HEIGHT
PSTEXCT0812*** **	800mm	1250mm	740mm
PSTEXCT1012*** **	1000mm	1250mm	740mm
PSTEXCT1212*** **	1200mm	1250mm	740mm
PSTEXCT1412*** **	1400mm	1250mm	740mm
PSTEXCT1612*** **	1600mm	1250mm	740mm
PSTEXCT1812*** **	1800mm	1250mm	740mm

# pico 120 degree desks /goalpost leg

## 1 Person 120 Degree Desk. Goalpost Leg. Fixed Top.

To attach a screen, please use a screen clamp.

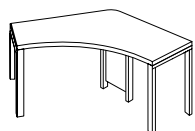

P1P120D11116 *** **	2200mm	600mm	740mm
P1P120D12126 *** **	2400mm	600mm	740mm

## 2 Person 120 Degree Desk. Goalpost Leg. Fixed Top.

To attach a screen, please use an intermediate screen rails.

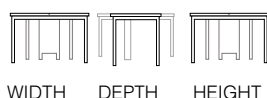
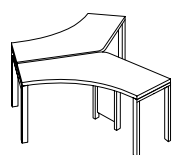

P2P120D11116 *** **	2200mm	1250mm	740mm
P2P120D12126 *** **	2400mm	1250mm	740mm

## 3 Person 120 Degree Desk. Goalpost Leg. Fixed Top.

To attach a screen, please use an intermediate screen rails.

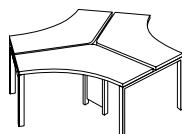

P3P120D11116 *** **	2200mm	1250mm	740mm
P3P120D12126 *** **	2400mm	1250mm	740mm

# /A-frame leg

## 1 Person 120 Degree Desk. A-Frame Leg. Fixed Top.

To attach a screen, please use a screen clamp.

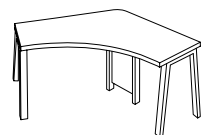

PA1P120D11116 *** **	2200mm	600mm	740mm
PA1P120D12126 *** **	2400mm	600mm	740mm

## 2 Person 120 Degree Desk. A-Frame Leg. Fixed Top.

To attach a screen, please use an intermediate screen rails.

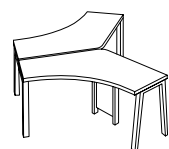

PA2P120D11116 *** **	2200mm	1250mm	740mm
PA2P120D12126 *** **	2400mm	1250mm	740mm

### 3 Person 120 Degree Desk. A-Frame Leg. Fixed Top.

To attach a screen, please use an intermediate screen rails.

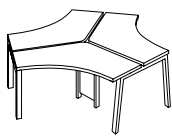

PA3P120D11116 *** **	2200mm	1250mm	740mm
PA3P120D12126 *** **	2400mm	1250mm	740mm

## /rectangular loop legs

### 1 Person 120 Degree Desk. Rectangular Loop Leg. Fixed Top.

To attach a screen, please use a screen clamp.

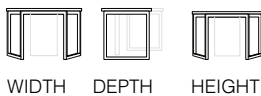
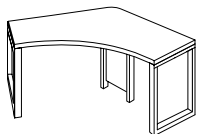

PR1P120D11116 *** **	2200mm	600mm	740mm
PR1P120D12126 *** **	2400mm	600mm	740mm

### 2 Person 120 Degree Desk. Rectangular Loop Leg. Fixed Top.

To attach a screen, please use an intermediate screen rails.

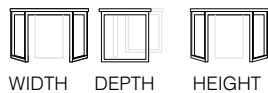
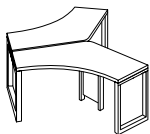

PR2P120D11116 *** **	2200mm	1250mm	740mm
PR2P120D12126 *** **	2400mm	1250mm	740mm

### 3 Person 120 Degree Desk. Rectangular Loop Leg. Fixed Top.

To attach a screen, please use an intermediate screen rails.

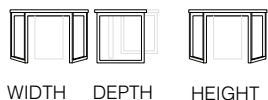
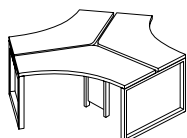

PR3P120D11116 *** **	2200mm	1250mm	740mm
PR3P120D12126 *** **	2400mm	1250mm	740mm

## pico desk returns

### Rectangular Desk Return. Goalpost Frame. Fixed Top.

Used to extend a desk, creating an L-Shape configuration.

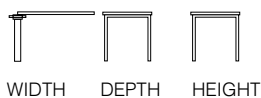
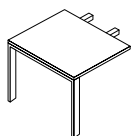

PRETURN0806 *** **	800mm	600mm	740mm
PRETURN1006 *** **	1000mm	600mm	740mm
PRETURN1206 *** **	1200mm	600mm	740mm

**Rectangular Desk Return. A-Frame Legs. Fixed Top.**

Used to extend a desk, creating an L-Shape configuration.

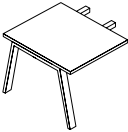

	WIDTH	DEPTH	HEIGHT
PARETURN0806 *** **	800mm	600mm	740mm
PARETURN1006 *** **	1000mm	600mm	740mm
PARETURN1206 *** **	1200mm	600mm	740mm

**Rectangular Desk Return. Rectangular Loop Leg. Fixed Top.**

Used to extend a desk, creating an L-Shape configuration.

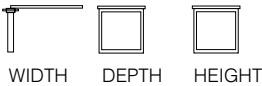
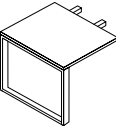

	WIDTH	DEPTH	HEIGHT
PRRETURN0806 *** **	800mm	600mm	740mm
PRRETURN1006 *** **	1000mm	600mm	740mm
PRRETURN1206 *** **	1200mm	600mm	740mm

**Sliding Tops**

These returns can be made in to a sliding top, each set consists of 2 links with screws. Requires manual positioning and fixing.

PRETURNSLIDEKIT\*\*\* Steel Finishes

# modesty panels

## Modesty Panels for Side-to-Side Benches.

Single, side or middle modesty panel. Single modesty panels are for single desks. For side-to-side benches, desk 1 at the start of the row requires a side modesty panel, the end of the row requires a side modesty panel. All desks in between require a middle modesty panel.

### SELECTING THE RIGHT MODESTY PANEL



#### Side Modesty Panel.

For side-to-side benches.

	DESK WIDTH	DEPTH	HEIGHT
PMOD800SIDE***	800mm	36mm	300mm
PMOD1000SIDE***	1000mm	36mm	300mm
PMOD1200SIDE***	1200mm	36mm	300mm
PMOD1400SIDE***	1400mm	36mm	300mm
PMOD1600SIDE***	1600mm	36mm	300mm
PMOD1800SIDE***	1800mm	36mm	300mm

#### Middle Modesty Panel.

For side-to-side benches.

	DESK WIDTH	DEPTH	HEIGHT
PMOD800MIDDLE***	800mm	36mm	300mm
PMOD1000MIDDLE***	1000mm	36mm	300mm
PMOD1200MIDDLE***	1200mm	36mm	300mm
PMOD1400MIDDLE***	1400mm	36mm	300mm
PMOD1600MIDDLE***	1600mm	36mm	300mm
PMOD1800MIDDLE***	1800mm	36mm	300mm

#### Single Modesty Panel.

For side-to-side benches.

	DESK WIDTH	DEPTH	HEIGHT
PMOD800SGL***	800mm	36mm	300mm
PMOD1000SGL***	1000mm	36mm	300mm
PMOD1200SGL***	1200mm	36mm	300mm
PMOD1400SGL***	1400mm	36mm	300mm
PMOD1600SGL***	1600mm	36mm	300mm
PMOD1800SGL***	1800mm	36mm	300mm

#### Suspended Modesty Panels.

Suspended modesty panels (not fixed to legs). Fixings included.

	DESK WIDTH	DEPTH	HEIGHT
JMOD08***P	800mm	36mm	317mm
JMOD10***P	1000mm	36mm	317mm
JMOD12***P	1200mm	36mm	317mm
JMOD14***P	1400mm	36mm	317mm
JMOD16***P	1600mm	36mm	317mm
JMOD18***P	1800mm	36mm	317mm

# rails & cable trays

## Cable Management Trays Suitable for Back-to-Back Benches.

	DESK WIDTH	DEPTH	HEIGHT
PBBTRAY800***	800mm	418mm	79mm
PBBTRAY1000***	1000mm	418mm	79mm
PBBTRAY1200***	1200mm	418mm	79mm
PBBTRAY1400***	1400mm	418mm	79mm
PBBTRAY1600***	1600mm	418mm	79mm
PBBTRAY1800***	1800mm	418mm	79mm

## Cable Trays for Single and Side-to-Side Benches.

PSTRAY900\*\*\* and PSTRAY1000\*\*\* for 120 degree desks.

	DESK WIDTH	DEPTH	HEIGHT
PSTRAY800***	800mm	148mm	79mm
PSTRAY900***	900mm	148mm	79mm
PSTRAY1000***	1000mm	148mm	79mm
PSTRAY1200***	1200mm	148mm	79mm
PSTRAY1400***	1400mm	148mm	79mm
PSTRAY1600***	1600mm	148mm	79mm
PSTRAY1800***	1800mm	148mm	79mm



## Screen Infills for Back-to-Back Desks with No Screen. (One.)

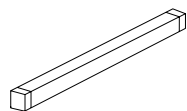

	WIDTH	DEPTH	HEIGHT
PSCRINFILL800***	800mm	25mm	25mm
PSCRINFILL1000***	1000mm	25mm	25mm
PSCRINFILL1200***	1200mm	25mm	25mm
PSCRINFILL1400***	1400mm	25mm	25mm
PSCRINFILL1600***	1600mm	25mm	25mm
PSCRINFILL1800***	2000mm	25mm	25mm

## Intermediate Bracket for Pico 120 degree desks and Screens

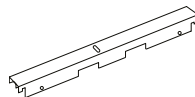

JSCRINTRAILPICO\*\*\*

## Screen Support Rail &amp; Screen Posts.

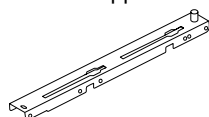

PUNISUPT800\*\*\*

## fixed height adjustment kits

Raises the desk by 40mm, 60mm or 80mm. Non adjustable. Silver or white as standard. Graphite, black and grey available at an upcharge. The fixed desk can be increased by 40mm, 60mm or 80mm, select '40', '60' or '80' for the height code. Ideally the kits need to be specified BEFORE the installation of the desk commences, however desks can be retro fitted at any time. Dismantling of the existing desk will be necessary, please allow for extra time/cost when retro fitting.

## Fixed Height Adjustment Kits for Single Desks.

Use for Pico single desks only.

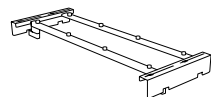

	WIDTH	DEPTH	HEIGHT RANGE
PSHAKIT0808 ** ** P	800mm	800mm	40/60/80
PSHAKIT1008 ** ** P	1000mm	800mm	40/60/80
PSHAKIT1208 ** ** P	1200mm	800mm	40/60/80
PSHAKIT1408 ** ** P	1400mm	800mm	40/60/80
PSHAKIT1608 ** ** P	1600mm	800mm	40/60/80
PSHAKIT1808 ** ** P	1800mm	800mm	40/60/80
PSHAKIT2008 ** ** P	2000mm	800mm	40/60/80

## Fixed Height Adjustment Kits for Back to Back (1 Desk Raised).

Use for Pico back to back desks only.

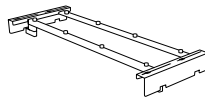

	WIDTH	DEPTH	HEIGHT RANGE
P1HAKIT0808 ** ** P	800mm	800mm	40/60/80
P1HAKIT1008 ** ** P	1000mm	800mm	40/60/80
P1HAKIT1208 ** ** P	1200mm	800mm	40/60/80
P1HAKIT1408 ** ** P	1400mm	800mm	40/60/80
P1HAKIT1608 ** ** P	1600mm	800mm	40/60/80
P1HAKIT1808 ** ** P	1800mm	800mm	40/60/80
P1HAKIT2008 ** ** P	2000mm	800mm	40/60/80

## Fixed Height Adjustment Kits for Back to Back (Both Desk Raised).

Use for Pico back to back desks only.

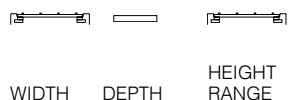
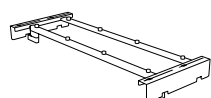

	WIDTH	DEPTH	HEIGHT RANGE
P2HAKIT0808 ** ** P	800mm	800mm	40/60/80
P2HAKIT1008 ** ** P	1000mm	800mm	40/60/80
P2HAKIT1208 ** ** P	1200mm	800mm	40/60/80
P2HAKIT1408 ** ** P	1400mm	800mm	40/60/80
P2HAKIT1608 ** ** P	1600mm	800mm	40/60/80
P2HAKIT1808 ** ** P	1800mm	800mm	40/60/80
P2HAKIT2008 ** ** P	2000mm	800mm	40/60/80



# crank desks

## HOW TO SPECIFY CRANK DESKS



CODE  
(E.G: 'ADHACR21206M')

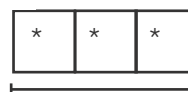

STEEL COLOUR \*\*\*  
(E.G: 'JOS')

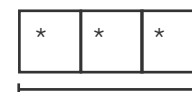

TOP COLOUR \*\*\*  
(E.G: 'WHM')

For example, to specify a height adjustable desk by crank handle, with a modesty panel style in silver steel with a white MFC top, measurements 1200mm (w) x 800mm (d) x 665mm/ 965mm (h) the code would be ADHACR21208MJOSWHM

### Steel Finishes

Silver	JOS
Graphite	GGS
Pale Grey	PGS
White	JWS
Black	BLS

### Band 1 MFC Finishes

White	WHM
White/ Oak Edge	WHO
White/ Black Edge	WHB
Pale Grey	MOG
Dust Grey	DGM
Light Oak*	MOK*
Walnut*	MOW*

*\*Please note, we cannot guarantee continuity of these finishes.*

### Band 2 MFC Finishes

Cashmere Grey	MSC
Antique Rose	MAR
Reed Green	MRG
Denim Blue	MDB
Hamilton Oak	MHO
Nebraska Oak	MNO
Truffle Brown Oak	MDO
Natural Carini Walnut	MCW
Sevilla Ash	MSA
Chicago Concrete	MCC

# crank height adjustable desk

## Height Adjustable Desk by Crank Handle.

Modesty panel style. Cable tray not included.

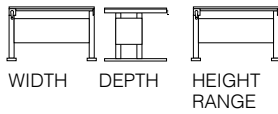
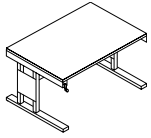

	WIDTH	DEPTH	HEIGHT RANGE
ADHACR21206M *** **	1200mm	600mm	665 - 965mm
ADHACR21406M *** **	1400mm	600mm	665 - 965mm
ADHACR21606M *** **	1600mm	600mm	665 - 965mm
ADHACR21806M *** **	1800mm	600mm	665 - 965mm
ADHACR21208M *** **	1200mm	800mm	665 - 965mm
ADHACR21408M *** **	1400mm	800mm	665 - 965mm
ADHACR21608M *** **	1600mm	800mm	665 - 965mm
ADHACR21808M *** **	1800mm	800mm	665 - 965mm

## Height Adjustable Desk by Crank Handle.

Beam style. Cable tray not included.

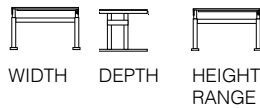
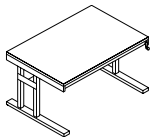

	WIDTH	DEPTH	HEIGHT RANGE
ADHACR21206B *** **	1200mm	600mm	665 - 965mm
ADHACR21406B *** **	1400mm	600mm	665 - 965mm
ADHACR21606B *** **	1600mm	600mm	665 - 965mm
ADHACR21806B *** **	1800mm	600mm	665 - 965mm
ADHACR21208B *** **	1200mm	800mm	665 - 965mm
ADHACR21408B *** **	1400mm	800mm	665 - 965mm
ADHACR21608B *** **	1600mm	800mm	665 - 965mm
ADHACR21808B *** **	1800mm	800mm	665 - 965mm



# a-up desks

## HOW TO SPECIFY A-UP DESKING

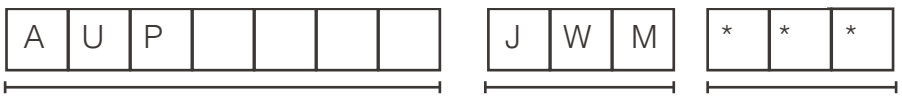

**CODE**  
(E.G: 'AUP1408')

**FRAME COLOUR**  
(‘JWM’ White Only)

**MFC FINISH**  
(E.G: ‘WHM’)

For example, to specify a single 1370mm (w) x 780mm (d) x 610mm - 1260mmmm (h) A-Up desk, white MFC top and white I-frame leg the code would be AUP1408JWMWHM. When ordering a number of desks for a side-to-side configuration, please order an appropriate spacing bracket to ensure it’s compliance to BS EN 527-2:2016.

**Steel Finishes**

White Only                      JWM

**Band 1 MFC Finishes**

- |                   |      |
|-------------------|------|
| White             | WHM  |
| White/ Oak Edge   | WHO  |
| White/ Black Edge | WHB  |
| Pale Grey         | MOG  |
| Dust Grey         | DGM  |
| Light Oak*        | MOK* |
| Walnut*           | MOW* |

*\*Please note, we cannot guarantee continuity of these finishes.*

**Band 2 MFC Finishes**

- |                       |     |
|-----------------------|-----|
| Cashmere Grey         | MSC |
| Antique Rose          | MAR |
| Reed Green            | MRG |
| Denim Blue            | MDB |
| Hamilton Oak          | MHO |
| Nebraska Oak          | MNO |
| Truffle Brown Oak     | MDO |
| Natural Carini Walnut | MCW |
| Sevilla Ash           | MSA |
| Chicago Concrete      | MCC |

# a-up height adjustable desk /single & back-to-back desks

## A-Up single sit/stand desk.

Anti-Collision as standard. I-frame leg.

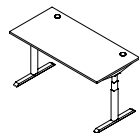

WIDTH



DEPTH



HEIGHT

AUP1408JWS ***	1370mm	780mm	610 - 1260mm
AUP1608JWS ***	1570mm	780mm	610 - 1260mm
AUP1808JWS ***	1770mm	780mm	610 - 1260mm
AUP2008JWS ***	1970mm	780mm	610 - 1260mm

## A-Up back-to-back sit/stand desk.

Anti-Collision as standard. I-frame leg with connecting rail.

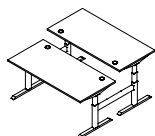

WIDTH



DEPTH



HEIGHT

AUP1416JWS ***	1370mm	1650mm	610 - 1260mm
AUP1616JWS ***	1570mm	1650mm	610 - 1260mm
AUP1816JWS ***	1770mm	1650mm	610 - 1260mm
AUP2016JWS ***	1970mm	1650mm	610 - 1260mm

## A-Up back-to-back sit/stand desk with cable management.

Anti-Collision as standard. I-frame leg with connecting rail, cable tray and translucent cable spines.

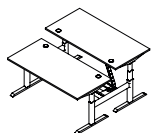

WIDTH



DEPTH



HEIGHT

AUP1416TRAYJWS ***	1370mm	1650mm	610 - 1260mm
AUP1616TRAYJWS ***	1570mm	1650mm	610 - 1260mm
AUP1816TRAYJWS ***	1770mm	1650mm	610 - 1260mm
AUP2016TRAYJWS ***	1970mm	1650mm	610 - 1260mm

## /accessories

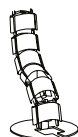

**A-Up cable spine.** Feeds cables from the cable tray to the floor.

JUPSPINEJWS

White

JUPSPINEJOS

Silver

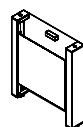

**A-Up back-to-back with cable management mini tower.**

Feeds cables from the cable tray to the floor.

AUPTOWERJWS

White

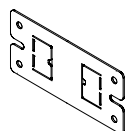

**A-Up spacing brackets.** Compatible with both single sided and back-to-back desks. One required per joint.

Ensures desk stay a safe space apart. A spacing bracket MUST be specified to comply with BS EN 527-2:2016

AUPLINKBRKTJWS

White



# jot-up desks

## HOW TO SPECIFY JOT-UP DESKING



JOT-UP CODE  
(E.G: 'JUP1416MOTTWR')

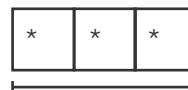

STEEL FINISH  
(E.G: 'JWM')



MFC FINISH  
(E.G: 'WHM')

To specify a Jot-Up fully cable managed desk 1400mm x 1650mm with electric lifting columns, white top and white frame the code would be JUP1416MOTTWRJWMWHM.

Please note, Fyn screens are not compatible with Jot-Up desks.

### Steel Finishes

Silver	JOM
White	JWM
Black	BLM

### Band 1 MFC Finishes

White	WHM
White/ Oak Edge	WHO
White/ Black Edge	WHB
Pale Grey	MOG
Dust Grey	DGM
Light Oak*	MOK*
Walnut*	MOW*

*\*Please note, we cannot guarantee continuity of these finishes.*

### Band 2 MFC Finishes

Cashmere Grey	MSC
Antique Rose	MAR
Reed Green	MRG
Denim Blue	MDB
Hamilton Oak	MHO
Nebraska Oak	MNO
Truffle Brown Oak	MDO
Natural Carini Walnut	MCW
Sevilla Ash	MSA
Chicago Concrete	MCC

### Note

If you select a battery, please keep the battery charged to prevent irreversible damage. The battery level should be checked regularly, an audible alarm (beeping) will signal that the battery needs charging. If the battery is allowed to run flat and left dormant for a long period of time, it will go into deep discharge and it will not be possible to re-charge.

# jot-up

## /single & back-to-back desks

### Jot-Up Lite Single Desk with Motor Driven Lifting Columns.

Overall desk height 610mm - 1260mm.

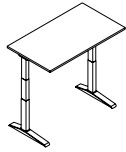

WIDTH



DEPTH



HEIGHT

JUP1008MOTLEG *** **	970mm	780mm	610 - 1260mm
JUP1208MOTLEG *** **	1170mm	780mm	610 - 1260mm
JUP1408MOTLEG *** **	1370mm	780mm	610 - 1260mm
JUP1608MOTLEG *** **	1570mm	780mm	610 - 1260mm
JUP1808MOTLEG *** **	1770mm	780mm	610 - 1260mm

### Jot-Up Lite Back-to-Back Desk with Motor Driven Lifting Columns.

Overall desk height 610mm - 1260mm.

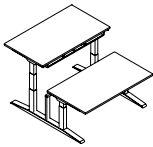

WIDTH



DEPTH



HEIGHT

JUP1016MOTLEG *** **	970mm	1650mm	610 - 1260mm
JUP1216MOTLEG *** **	1170mm	1650mm	610 - 1260mm
JUP1416MOTLEG *** **	1370mm	1650mm	610 - 1260mm
JUP1616MOTLEG *** **	1570mm	1650mm	610 - 1260mm
JUP1816MOTLEG *** **	1770mm	1650mm	610 - 1260mm

### Jot-Up Single Desk with Motor Driven Lifting Columns.

Overall desk height 610mm - 1260mm.

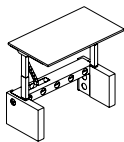

WIDTH



DEPTH



HEIGHT

JUP1008MOTTWR *** **	970mm	780mm	610 - 1260mm
JUP1208MOTTWR *** **	1170mm	780mm	610 - 1260mm
JUP1408MOTTWR *** **	1370mm	780mm	610 - 1260mm
JUP1608MOTTWR *** **	1570mm	780mm	610 - 1260mm
JUP1808MOTTWR *** **	1770mm	780mm	610 - 1260mm

### Jot-Up Back-to-Back Desk with Motor Driven Lifting Columns.

Overall desk height 610mm - 1260mm.

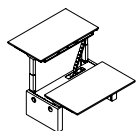

WIDTH



DEPTH



HEIGHT

JUP1016MOTTWR *** **	970mm	1650mm	610 - 1260mm
JUP1216MOTTWR *** **	1170mm	1650mm	610 - 1260mm
JUP1416MOTTWR *** **	1370mm	1650mm	610 - 1260mm
JUP1616MOTTWR *** **	1570mm	1650mm	610 - 1260mm
JUP1816MOTTWR *** **	1770mm	1650mm	610 - 1260mm

# /accessories

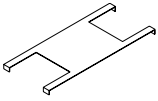

**Jot-Up Lite Side-To-Side Spacing Brackets (Single).** 1 required for single desks, 2 required for back-to-back desks.

JUPBLEGBRKT\*\*\* Steel Finishes

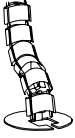

**Jot-Up Cable Spine for Jot-Up Lite.** Feeds cables from the cable tray to the floor.

JUPSPINEJWS White  
JUPSPINEJOS Silver

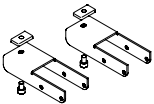

**Jot-Up Lite Screen Bracket (Pair).**

For single or side-to-side desks.

JUPSCRLEGBRKT\*\*\* Steel Finishes

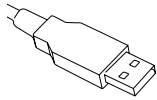

**Desk Control for Jot-Up & Jot-Up Lite.**

Connects desk to Linak Desk Control Software.

JUPUSB Cable  
JUPBLUE Bluetooth Dongle

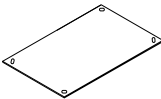

**Jot-Up Side-To-Side Spacing Brackets (Single).**

1 required for single connecting desks. Back-to-back desks require 2.

JUPTWRBRKT\*\*\* Steel Finishes

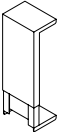

**CPU Holder for Jot-Up & Jot-Up Lite.**

For 290mm - 500mm high CPU's.

JUPCPU\*\*\* Steel Finishes

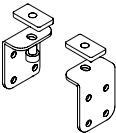

**Jot-Up Screen Brackets (Pair).**

For single or side-to-side desks.

JUPSCRTWRBRKT\*\*\* Steel Finishes

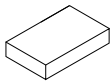

**Lithium Ion Battery Pack for Jot-Up & Jot-Up Lite.**

Includes DC battery pack, cable and mount plate

Please note charging below.

JUPBAT\*\*\* N/a







# aero screens

## HOW TO SPECIFY AERO SCREENS

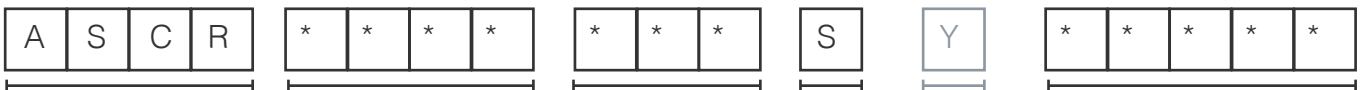

**TOP CODE**  
(For example: 'ASCR')

**WIDTH**  
(For example: '1400')

**HEIGHT**  
(For example: '380')

**S**  
( 'S' ONLY )

**Y**  
( 'Y' ONLY )

**FABRIC**  
(For example: 'LDS49')

For example, to specify a Aero 1400x380mm screen (above) in Camira Synergy, Append LDS49, the code would be ASCR1400380SLDS49

### Notes

Screen Depth  
Foam Backed: 34mm deep.  
Standard fabric: 27mm deep.

A-Up and Jot-Up Lite Single Desks and Side-to-Side Desks, require bespoke screen sizes. ie.970mm/1170mm/1370mm /1570mm/ 1770mm/1970mm

### Band A Fabric

Camira Cara

### Band B Fabric

Camira Lucia

### Band C Fabric

Camira Blazer Lite

### Band D Fabric

Camira Synergy  
Camira Blazer

### Band Y Fabrics (Foam Backed)

- Camira Blazer Lite, Balance, LTH41
- Camira Blazer Lite, Buddha LTH56
- Camira Blazer Lite, Cuddle, LTH62
- Camira Blazer Lite, Dainty, LTH64
- Camira Blazer Lite, Daydream, LTH46
- Camira Blazer Lite, Devoted, LTH58
- Camira Blazer Lite, Happy, LTH55
- Camira Blazer Lite, Harmony, LTH63
- Camira Blazer Lite, Haven, LTH40
- Camira Blazer Lite, Mood, LTH44
- Camira Blazer Lite, Retreat, LTH39
- Camira Blazer Lite, Solace, LTH70
- Camira Blazer Lite, Tender, LTH53
- Camira Blazer Lite, True, LTH61
- Camira Blazer Lite, Wish, LTH67
- Camira Blazer Lite, Angel, LTH49
- Camira Blazer Lite, Hope, LTH50

## aero

## Aero Screen.

Desk Mounted Screen suitable for Pico, Meira and Todd Desks.



	WIDTH	DEPTH*	HEIGHT
--	-------	--------	--------

ASCR0800380S * *****	800mm	27/34mm	380mm
ASCR1000380S * *****	1000mm	27/34mm	380mm
ASCR1200380S * *****	1200mm	27/34mm	380mm
ASCR1400380S * *****	1400mm	27/34mm	380mm
ASCR1600380S * *****	1600mm	27/34mm	380mm
ASCR1650380S * *****	1650mm	27/34mm	380mm
ASCR1800380S * *****	1800mm	27/34mm	380mm

## Aero Screen.

Desk Mounted Screen suitable for Jot-Up Desks, and A-Up/Jot-Up Lite Back-to-Back Desks Only.



	WIDTH	DEPTH*	HEIGHT
--	-------	--------	--------

ASCR0800665S * *****	800mm	27/34mm	665mm
ASCR1000665S * *****	1000mm	27/34mm	665mm
ASCR1200665S * *****	1200mm	27/34mm	665mm
ASCR1400665S * *****	1400mm	27/34mm	665mm
ASCR1600665S * *****	1600mm	27/34mm	665mm
ASCR1800665S * *****	1800mm	27/34mm	665mm

## Aero Spigot Bracket, Pair (Black Only, Not Visable).

ASCRSPIGOTBRKT

## Aero Spigot Clamping Bracket, Pair (Black BLM, Silver JOM, White WHM, Ebony EBS)

ASCRSBKT07 \*\*\*

## Screen &amp; Bracket Compatibility

Desk Range/ Configuration	Screen Size	Aero Spigot Bracket	Aero Spigot Clamping Bracket	Additional Brackets
Pico Single Desk	380mm high	Yes	-	+ PUNISUPT800***
Pico Side-to-Side Desk	380mm high	Yes	-	+ PUNISUPT800***
Pico Back-to-Back Desk	380mm high	Yes	-	-
Meira Single Desk	380mm high	Yes	-	+ MSSSCRBRKT***
Meira Side-to-Side Desk	380mm high	Yes	-	+ MSSSCRBRKT***
Meira Back-to-Back Desk	380mm high	Yes	-	+ MBBSRBRKT***
Todd Single Desk	380mm high	-	Yes	-
Todd Side-to-Side Desk	380mm high	-	Yes	-
Todd Back-to-Back Desk	380mm high	Yes	-	+ TODSCRBRKT***
A-Up Single Desk*	Bespoke width	-	Yes	-
A-Up Side-to-Side Desk*	Bespoke width	-	Yes	+ JUPSCRLEGBRKT***
A-Up Back-to-Back Desk	665mm high	Yes	-	-
Jot-Up Single Desk	665mm high	Yes	-	+ JUPSCRTRWRBRKT***
Jot-Up Side-to-Side Desk	665mm high	Yes	-	+ JUPSCRTRWRBRKT***
Jot-Up Back-to-Back Desk	665mm high	Yes	-	-
Jot-Up Lite Single Desk*	Bespoke width	Yes	-	+ JUPSCRLEGBRKT***
Jot-Up Lite Side-to-Side Desk*	Bespoke width	Yes	-	+ JUPSCRLEGBRKT***
Jot-Up Lite Back-to-Back Desk	665mm high	Yes	-	-

# sound acoustic panels

## HOW TO SPECIFY SOUND

S	O	U	N	D	*
---	---	---	---	---	---

CODE  
(E.G: 'SOUNDH' shown above)

*	*	*	*	*
---	---	---	---	---

FABRIC FINISH  
(E.G: 'LDS49')

For example, to specify a Sound hexagon shape panel in Camira Synergy, Append LDS49, the code would be SOUNDHLDS49

### Shapes

Circular	C
Square	S
Rectangular	R
Pentagon	P
Haxagon	H
Flux	F

### Band 1 Fabrics

Camira Lucia
Camira Era

### Band 2 Fabrics

Camira Quest
--------------





### Band 3 Fabrics

Camira Blazer
Camira Synergy
Camira Main Line Flax
Camira Main Line Twist

# sound

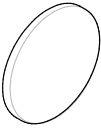



## Circular Acoustic Panel

Velco back as standard.

			
	WIDTH	DEPTH	HEIGHT
SOUNDC *****	435mm	39mm	435mm
SOUNDCL *****	600mm	39mm	600mm

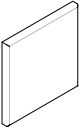



## Square/ Rectangle Acoustic Panel

Velco back as standard.

			
	WIDTH	DEPTH	HEIGHT
SOUNDS *****	435mm	39mm	435mm
SOUNDSL *****	600mm	39mm	600mm
SOUNDR *****	870mm	39mm	435mm





## Pentagon Acoustic Panel

Velco back as standard.

			
	WIDTH	DEPTH	HEIGHT
SOUNDP *****	410mm	39mm	390mm





## Hexagon Acoustic Panel

Velco back as standard.

			
	WIDTH	DEPTH	HEIGHT
SOUNDH *****	502mm	39mm	435mm

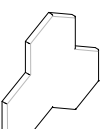
## Flux Acoustic Panel

Velco back as standard.

			
	WIDTH	DEPTH	HEIGHT
SOUNDF *****	865mm	39mm	875mm

## Optional Wall Mounted Fixing Kit

SOUNDWALLBRK

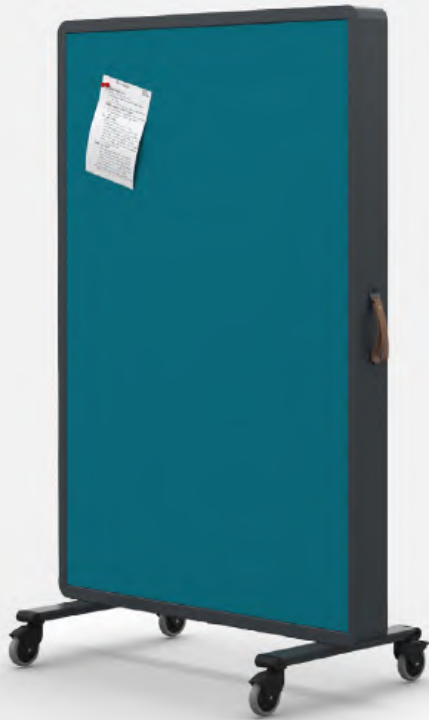

# hoop

## HOW TO SPECIFY HOOP



CODE  
(E.G: 'HO')

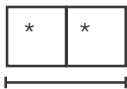

TYPE  
(E.G: '02')

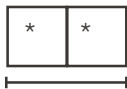

MFC COLOUR  
(E.G: 'OA')

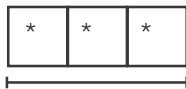

FRAME COLOUR  
(E.G: 'BLM')

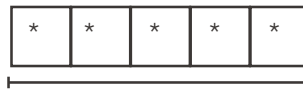

PANEL FABRIC COLOUR  
(EG: 'LTH41')

For example, to specify a Hoop Mobile Whiteboard and Pinboard with Low Storage Cupboard in Hamilton Oak, black frame and Blazer Lite Balance LTH41 the code would be HO02OABLMMLTH41

### MFC Colours

Hamilton Oak	OA
Sorano Oak	SO
Carbon Grey	GR
White	WH
Black	BK

### Frame Colour

Black	BLM
White	WHM
Silver	JOM
Reed Green	GRM
Pale Green	GCM
Salmon Pink	PSM
Clear Coat	CCG

### Fabric Color

Blazer Lite Balance	LTH41
Blazer Lite Buddha	LTH56
Blazer Lite Cuddle	LTH62
Blazer Lite Dainty	LTH64
Blazer Lite Daydream	LTH46
Blazer Lite Devoted	LTH58
Blazer Lite Happy	LTH55
Blazer Lite Harmony	LTH63
Blazer Lite Haven	LTH40
Blazer Lite Mood	LTH44
Blazer Lite Retreat	LTH39
Blazer Lite Solace	LTH70
Blazer Lite Tender	LTH53
Blazer Lite True	LTH61
Blazer Lite Wish	LTH67

# hoop

## Hoop Mobile Full Height Whiteboard & Pinboard.

Pen pot included. Leather handles with locking castors.



WIDTH



DEPTH



HEIGHT

HO 01ZZ \*\*\* \*\*\*\*\*

1200mm

582mm

1897mm

## Hoop Mobile Whiteboard & Pinboard with Low Storage Cupboard.

Pen tray is included. Leather handles with locking castors.



WIDTH



DEPTH



HEIGHT

HO 02 \*\* \*\*\* \*\*\*\*\*

1200mm

582mm

1897mm

## Hoop Mobile 3/4 Dual Whiteboard with Low Fabric Panel.

Pen tray is included. Leather handles with locking castors.

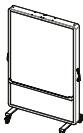

WIDTH



DEPTH



HEIGHT

HO 03ZZ \*\*\* \*\*\*\*\*

1200mm

582mm

1897mm

## Hoop Mobile 3/4 Dual Whiteboard with Low MFC Panel.

Pen tray is included. Leather handles with locking castors.

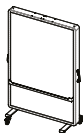

WIDTH



DEPTH



HEIGHT

HO 04 \*\* \*\*\* \*\*\*\*\*

1200mm

582mm

1897mm

## Hoop Mobile Media Wall & Whiteboard with Fabric Panel.

Pen tray is included. Leather handles with locking castors.

HO 05 includes TV brackets suitable for up to 48" TVs. HO 05 14 includes TV brackets suitable for up to 55".

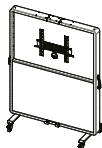

WIDTH



DEPTH



HEIGHT

HO 05 ZZ \*\*\* \*\*\*\*\*

1200mm

582mm

1897mm

HO 05 14 \*\*\* \*\*\*\*\*

1400mm

582mm

1900mm

**Hoop Mobile Bookshelf with Low Storage Cupboard.**

Leather handles with locking castors. Optional pack of 5 bookends.



WIDTH



DEPTH



HEIGHT

HO 06 ** ***	1200mm	582mm	1897mm
HOWHWL-BOOKENDS***	-	-	-

**Hoop Mobile 4 Tiered Plant Wall.**

Leather handles with locking castors. Capacity: 20 plants (not included). Waterproof liners included.



WIDTH



DEPTH



HEIGHT

HO 07 ZZ ***	1200mm	582mm	1897mm
--------------	--------	-------	--------

**Hoop Mobile 2 Tiered Plant Wall with Low Storage Cupboard.**

Leather handles with locking castors. Capacity: 10 plants (not included). Waterproof liners included.



WIDTH



DEPTH



HEIGHT

HO 08 ** ***	1200mm	582mm	1897mm
--------------	--------	-------	--------

**Hoop Mobile Coat Hangers with Low Storage Cupboard.**

Leather handles with locking castors. Includes 5 black hangers. Optional 5 pack available.

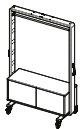

WIDTH



DEPTH



HEIGHT

HO 09 ** ***	1200mm	582mm	1897mm
HOWHWL-HANGERS	-	-	-





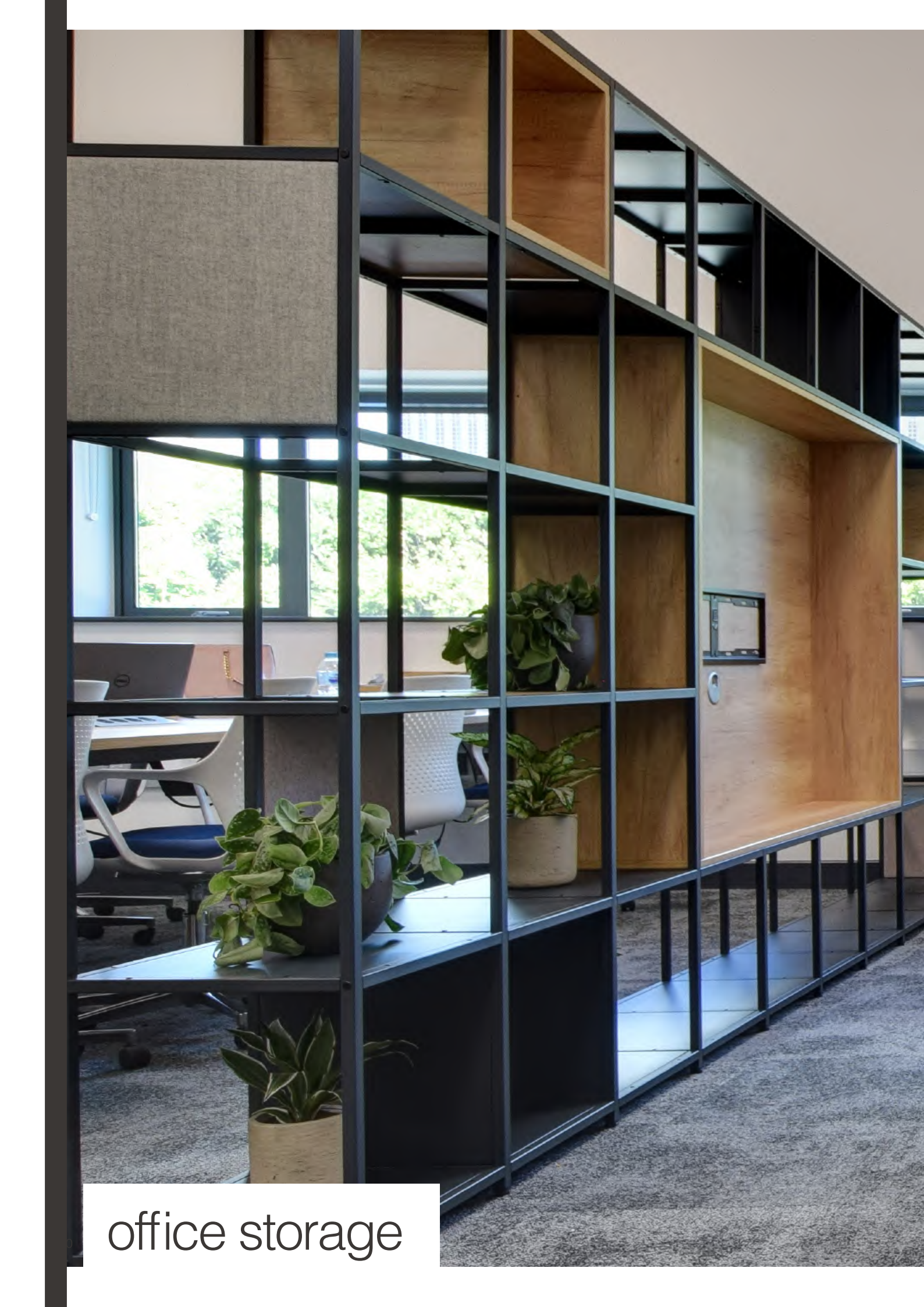

office storage



Rugby League Installation, FlexiGrid



# contract pedestals

## HOW TO SPECIFY PEDESTAL STORAGE

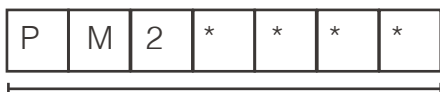

CODE  
(E.G: 'PM24521')



COLOUR  
(E.G: 'WHITE')

For example, to specify a 3 drawer all white 410mm (w) x 500mm (d) x 597mm (h) in white the code would be PM24521WHITE.  
All pedestals are supplied with pen trays and dividers.

### Steel Finishes

White 9016	WHITE
Silver 9006	SILVER
Black 9017	BLACK

# contract pedestal

## 597mm High Metal Pedestals.

Metal Pedestals, 4 castors, includes pen tray and divider.

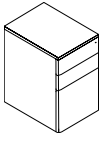

WIDTH



DEPTH



HEIGHT

PM23521 \*\*\*\*\*

300mm 500mm 597mm

PM24521 \*\*\*\*\*

410mm 500mm 597mm



# metro pedestals

## HOW TO SPECIFY PEDESTAL STORAGE

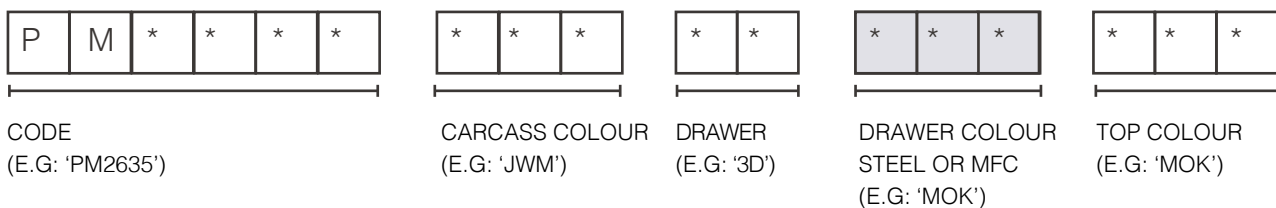

For example, to specify a 3 drawer white carcass with oak fronts, 300mm (w) x 600mm (d) x 600mm (h) mobile pedestal the code would be PM2635JWM3DMOKMOK. When ordering a pedestal consider internal drawers and pen trays.

Please note 720mm and 740mm high pedestals should be specified with a MFC top (included), mobile pedestals should be specified with a steel top.

**IMPORTANT NOTE:** The 'Drawer Colour' code specifies whether the pedestal is steel fronted or MFC fronted. Please ensure the finish code is selected off the correct finish sheet. For example white steel is 'JWS' while white MFC is 'WHM'.

### Finishes

Black, Matt	BLM	Patina Green, Matt	GAM
Graphite Grey, Matt	GGM	Pale Green, Matt	GCM
Jot Silver, Matt	JOM	Sapphire Blue, Matt	USM
Pale Grey, Matt	PGM	Violet Blue, Matt	UVM
White, Matt	JWM	Distant Blue, Matt	UDM
Pale Brown, Matt	BPM	Pastel Blue, Matt	UPM
Grey Beige, Matt	BGM	Purple Red, Matt	RPM
Beige, Matt	BBM	Red Violet, Matt	RYM
Light Ivory, Matt	BIM	Orient Red, Matt	ROM
Olive Green, Matt	GOM	Beige Red, Matt	RBM
Fern Green, Matt	GFM	Tomato Red, Matt	RTM
Reed Green, Matt	GRM	Salmon Pink, Matt	PSM
Black Green, Matt	GBM	Yellow Orange, Matt	OYM
Pine Green, Matt	GPM	Broom Yellow, Matt	YBM

### Band 1 MFC Finishes

White	WHM
Pale Grey	MOG
Dust Grey	DGM
Light Oak*	MOK*
Walnut*	MOW*

*\*Please note, we cannot guarantee continuity of these finishes.*

### Band 2 MFC Finishes

Cashmere Grey	MSC
Antique Rose	MAR
Reed Green	MRG
Denim Blue	MDB
Hamilton Oak	MHO
Nebraska Oak	MNO
Truffle Brown Oak	MDO
Natural Carini Walnut	MCW
Sevilla Ash	MSA
Chicago Concrete	MCC

# pedestals

## 740mm High Pedestals.

Available in 3 drawer and 2 drawer.

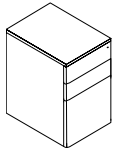

WIDTH



DEPTH



HEIGHT

PM27446\*\*\*3D\*\*\*\*\*

400mm

600mm

740mm

PM27448\*\*\*3D\*\*\*\*\*

400mm

800mm

740mm

## 720mm High Pedestals.

Available in 3 drawer.

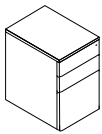

WIDTH



DEPTH



HEIGHT

PM2746\*\*\*3D\*\*\*\*\*

400mm

600mm

720mm

PM2748\*\*\*3D\*\*\*\*\*

400mm

800mm

720mm

## 600mm High Mobile Pedestals.

3 drawer. Available in 300mm width or 400mm width.

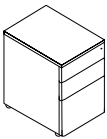

WIDTH



DEPTH



HEIGHT

PM2645\*\*\*3D\*\*\*\*\*

400mm

575mm

600mm

PM2635\*\*\*3D\*\*\*\*\*

300mm

575mm

600mm

## 470mm High Mobile Pedestals (1 Filing Drawer & 1 Personal Drawer).

2 drawer. Available in 300mm width or 400mm width.

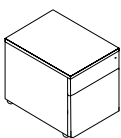

WIDTH



DEPTH



HEIGHT

PM24745\*\*\*2D\*\*\*\*\*

400mm

575mm

470mm

PM24735\*\*\*2D\*\*\*\*\*

300mm

575mm

470mm

# accessories

## Pen Trays.

Available to suit 300mm and 400mm drawers. Finished in black.

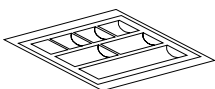

WIDTH



DEPTH



HEIGHT

PCPT42

400mm

357mm

25mm

MPCPT30BLS

300mm

357mm

25mm

## Dividers.

Available to suit 300mm and 400mm drawers. Finished in black.

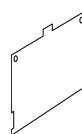

WIDTH



DEPTH



HEIGHT

PCDD42BLS

400mm

10mm

255mm

MPDD30BLS

300mm

10mm

255mm

# metro storage

## HOW TO SPECIFY METRO

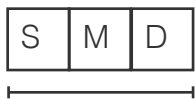

CODE  
(E.G: 'ADTABR41208')



SIZE  
(E.G: '1308')

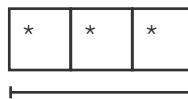

CARCASS COLOUR  
(E.G: 'JWM')

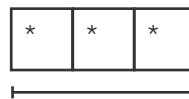

DOOR COLOUR  
(E.G: 'JWM')

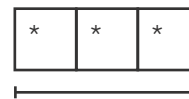

TOP COLOUR  
(E.G: 'JWM')

For example, to specify a 800mm (w) x 430mm (d) x 1320mm (h) all white Metro storage cupboard the code would be **SMD1308JWMJWMJWM**

### Steel Finishes

Black, Matt	BLM	Patina Green, Matt	GAM
Graphite Grey, Matt	GGM	Pale Green, Matt	GCM
Jot Silver, Matt	JOM	Sapphire Blue, Matt	USM
Pale Grey, Matt	PGM	Violet Blue, Matt	UVM
White, Matt	JWM	Distant Blue, Matt	UDM
Pale Brown, Matt	BPM	Pastel Blue, Matt	UPM
Grey Beige, Matt	BGM	Purple Red, Matt	RPM
Beige, Matt	BBM	Red Violet, Matt	RYM
Light Ivory, Matt	BIM	Orient Red, Matt	ROM
Olive Green, Matt	GOM	Beige Red, Matt	RBM
Fern Green, Matt	GFM	Tomato Red, Matt	RTM
Reed Green, Matt	GRM	Salmon Pink, Matt	PSM
Black Green, Matt	GBM	Yellow Orange, Matt	OYM
Pine Green, Matt	GPM	Broom Yellow, Matt	YBM

### Band 1 MFC Finishes

White	WHM
White/ Oak Edge	WHO
White/ Black Edge	WHB
Pale Grey	MOG
Dust Grey	DGM
Light Oak*	MOK*
Walnut*	MOW*

*\*Please note, we cannot guarantee continuity of these finishes.*

### Band 2 MFC Finishes

Cashmere Grey	MSC
Antique Rose	MAR
Reed Green	MRG
Denim Blue	MDB
Hamilton Oak	MHO
Nebraska Oak	MNO
Truffle Brown Oak	MDO
Natural Carini Walnut	MCW
Sevilla Ash	MSA
Chicago Concrete	MCC



# metro storage /cabinets

## Metro Storage Cabinet.

2 bar vertical locking bar system. Black/ Silver handle. Supplied with 2 keys (1 folding).

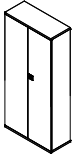

WIDTH



DEPTH



HEIGHT

SMD1908\*\*\* \*\*

800mm

430mm

1915mm

SMD1910\*\*\* \*\*

1000mm

430mm

1915mm

## Metro Storage Cabinet.

2 bar vertical locking bar system. Black/ Silver handle. Supplied with 2 keys (1 folding).

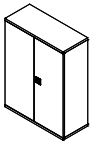

WIDTH



DEPTH



HEIGHT

SMD1308\*\*\* \*\*

800mm

430mm

1315mm

SMD1310\*\*\* \*\*

1000mm

430mm

1315mm

## Metro Storage Cabinet with MFC Top.

2 bar vertical locking bar system. MFC Top. Black/ Silver handle. Supplied with 2 keys (1 folding). Includes feet levellers.

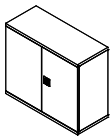

WIDTH



DEPTH



HEIGHT

SMD07408\*\*\* \*\*

800mm

430mm

740mm

SMD0740825\*\*\* \*\*

825mm

430mm

740mm

SMD07410\*\*\* \*\*

1000mm

430mm

740mm

## Metro Storage Cabinet with MFC Top.

2 bar vertical locking bar system. MFC Top. Black/ Silver handle. Supplied with 2 keys (1 folding). Includes feet levellers.

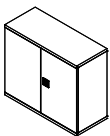

WIDTH



DEPTH



HEIGHT

SMD0708\*\*\* \*\*

800mm

430mm

720mm

SMD070825\*\*\* \*\*

825mm

430mm

720mm

SMD0710\*\*\* \*\*

1000mm

430mm

720mm

## MFC Tops for Tall Metro Units.

Optional extra.

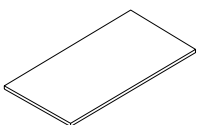

WIDTH



DEPTH



HEIGHT

METTOP0800\*\*\*

800mm

430mm

25mm

METTOP0825\*\*\*

825mm

430mm

25mm

METTOP1000\*\*\*

1000mm

430mm

25mm

**Metro Storage Shelves.**

Under-shelf suspended lateral filing rails included. Single shelf (01) or pack of 4 shelves (04).

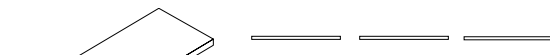

	WIDTH	FILING WIDTH	HEIGHT
SMCPS08***01	800mm	794mm	30mm
SMCPS08***04	825mm	794mm	30mm
SMCPS0825***01	1000mm	819mm	30mm
SMCPS0825***04	800mm	819mm	30mm
SMCPS10***01	825mm	994mm	30mm
SMCPS10***04	1000mm	994mm	30mm

**Metro Magnetic Shelf Dividers**

L Shape magnetic dividers. Pack of 3



	WIDTH	DEPTH	HEIGHT
SMCMAGD***03	100mm	320mm	170mm

**Metro Feet Levelling Kit**

SMLEVKIT





# freestor hinged door

## HOW TO SPECIFY A FREESTOR HINGED DOOR CABINET



CODE  
(E.G: 'FSL109010')

CARCASS COLOUR  
(E.G: 'JWM')

CODE  
(E.G: '26')

TOP COLOUR  
(E.G: 'JWM')

For example, to specify an all white 1000mm (w) x 475mm (d) x 1090mm (h) hinged door storage the code would be FSL109010JWM07JWM. When ordering a hinged door storage consider our components range.

For storage which meets desk height, select 740mm high storage (includes MFC top as standard).

**IMPORTANT NOTE:** Hinged Door Storage is all steel with a MFC top as an option. If a steel top is required select the desired steel colour in the \*\*\* section labelled 'Top Colour'. If an MFC top is required select a MFC colour. MFC tops incur an additional cost.

### Steel Finishes

Black, Matt	BLM	Patina Green, Matt	GAM
Graphite Grey, Matt	GGM	Pale Green, Matt	GCM
Jot Silver, Matt	JOM	Sapphire Blue, Matt	USM
Pale Grey, Matt	PGM	Violet Blue, Matt	UVM
White, Matt	JWM	Distant Blue, Matt	UDM
Pale Brown, Matt	BPM	Pastel Blue, Matt	UPM
Grey Beige, Matt	BGM	Purple Red, Matt	RPM
Beige, Matt	BBM	Red Violet, Matt	RYM
Light Ivory, Matt	BIM	Orient Red, Matt	ROM
Olive Green, Matt	GOM	Beige Red, Matt	RBM
Fern Green, Matt	GFM	Tomato Red, Matt	RTM
Reed Green, Matt	GRM	Salmon Pink, Matt	PSM
Black Green, Matt	GBM	Yellow Orange, Matt	OYM
Pine Green, Matt	GPM	Broom Yellow, Matt	YBM

### Band 1 MFC Finishes

White	WHM
White/ Oak Edge	WHO
White/ Black Edge	WHB
Pale Grey	MOG
Dust Grey	DGM
Light Oak*	MOK*
Walnut*	MOW*

*\*Please note, we cannot guarantee continuity of these finishes.*

### Band 2 MFC Finishes

Cashmere Grey	MSC
Antique Rose	MAR
Reed Green	MRG
Denim Blue	MDB
Hamilton Oak	MHO
Nebraska Oak	MNO
Truffle Brown Oak	MDO
Natural Carini Walnut	MCW
Sevilla Ash	MSA
Chicago Concrete	MCC

# freestor hinged door /without mfc top

## 2007mm High Hinged Door Storage.

Available in 800mm wide or 1000mm wide. Internal height: 1873mm

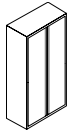

WIDTH



DEPTH



HEIGHT

FSL200708***04***	800mm	475mm	2007mm
FSL200710***04***	1000mm	475mm	2007mm

## 1677mm High Hinged Door Storage.

Available in 800mm wide or 1000mm wide. Internal height: 1543mm

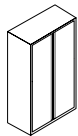

WIDTH



DEPTH



HEIGHT

FSL167708***07***	800mm	475mm	1677mm
FSL167710***07***	1000mm	475mm	1677mm

## 1322mm High Hinged Door Storage.

Available in 800mm wide or 1000mm wide. Internal height: 1181mm

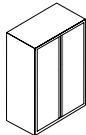

WIDTH



DEPTH



HEIGHT

FSL132208***09***	800mm	475mm	1322mm
FSL132210***09***	1000mm	475mm	1322mm

## 1017mm High Hinged Door Storage.

Available in 800mm wide or 1000mm wide. Internal height: 883mm.

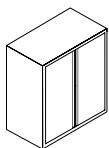

WIDTH



DEPTH



HEIGHT

FSL101708***10***	800mm	475mm	1017mm
FSL101710***10***	1000mm	475mm	1017mm

# /with mfc top

## 1110mm High Hinged Door Storage with MFC Top.

Available in 800mm wide, 825mm wide or 1000mm wide. Internal height: 960mm

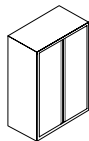

WIDTH



DEPTH



HEIGHT

FSL111008***27***	800mm	475mm	1110mm
FSL11100825***27***	825mm	475mm	1110mm
FSL111010***27***	1000mm	475mm	1110mm

## 1090mm High Hinged Door Storage with MFC Top.

Available in 800mm wide, 825mm wide or 1000mm wide. Internal height: 960mm

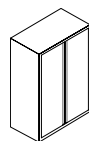

WIDTH



DEPTH



HEIGHT

FSL109008***26***	800mm	475mm	1090mm
FSL10900825***26***	825mm	475mm	1090mm
FSL109010***26***	1000mm	475mm	1090mm

## 740mm High Hinged Door Storage with MFC Top.

Available in 800mm wide, 825mm or 1000mm wide. Internal height: 578mm.

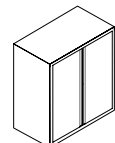

WIDTH



DEPTH



HEIGHT

FSL074008***24***	800mm	475mm	740mm
FSL07400825***24***	825mm	475mm	740mm
FSL074010***24***	1000mm	475mm	740mm

## 720mm High Hinged Door Storage with MFC Top.

Available in 800mm wide or 1000mm wide. Internal height: 578mm.

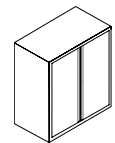

WIDTH



DEPTH



HEIGHT

FSL072008***25***	800mm	475mm	720mm
FSL07200825***25***	825mm	475mm	720mm
FSL072010***25***	1000mm	475mm	720mm





# freestor side filer storage

## HOW TO SPECIFY A FREESTOR SIDE FILER CABINET

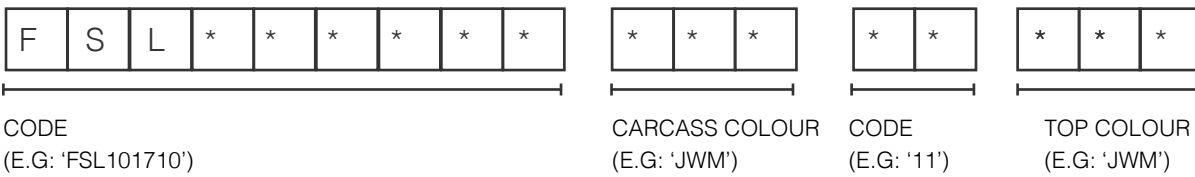

For example, to specify an all white 1000mm (w) x 475mm (d) x 1017mm (h) side filer storage, the code would be FSL101710JWM11JWM. When ordering a side filer storage consider components. All internal drawers are black inside. It is compulsory that a counterbalance weight is ordered when more than one pull out drawer is fitted.

**IMPORTANT NOTE:** Side Filer Storage is all steel with a MFC top as an option. If a steel top is required select the desired steel colour in the \*\*\* section labelled 'Top Colour'. If an MFC top is required select a MFC colour. MFC tops incur an additional cost.

### Steel Finishes

Black, Matt	BLM	Patina Green, Matt	GAM
Graphite Grey, Matt	GGM	Pale Green, Matt	GCM
Jot Silver, Matt	JOM	Sapphire Blue, Matt	USM
Pale Grey, Matt	PGM	Violet Blue, Matt	UVM
White, Matt	JWM	Distant Blue, Matt	UDM
Pale Brown, Matt	BPM	Pastel Blue, Matt	UPM
Grey Beige, Matt	BGM	Purple Red, Matt	RPM
Beige, Matt	BBM	Red Violet, Matt	RYM
Light Ivory, Matt	BIM	Orient Red, Matt	ROM
Olive Green, Matt	GOM	Beige Red, Matt	RBM
Fern Green, Matt	GFM	Tomato Red, Matt	RTM
Reed Green, Matt	GRM	Salmon Pink, Matt	PSM
Black Green, Matt	GBM	Yellow Orange, Matt	OYM
Pine Green, Matt	GPM	Broom Yellow, Matt	YBM

### Band 1 MFC Finishes

White	WHM
White/ Oak Edge	WHO
White/ Black Edge	WHB
Pale Grey	MOG
Dust Grey	DGM
Light Oak*	MOK*
Walnut*	MOW*

*\*Please note, we cannot guarantee continuity of these finishes.*

### Band 2 MFC Finishes

Cashmere Grey	MSC
Antique Rose	MAR
Reed Green	MRG
Denim Blue	MDB
Hamilton Oak	MHO
Nebraska Oak	MNO
Truffle Brown Oak	MDO
Natural Carini Walnut	MCW
Sevilla Ash	MSA
Chicago Concrete	MCC



# freestor side filer

Note: Side filers require a counterbalance weight.

## /without mfc top

### 1322mm High Side Filer Storage.

4x 12" (305mm) drawers.

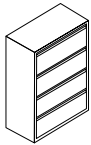

WIDTH



DEPTH



HEIGHT

FSL132208\*\*\*08\*\*\*

800mm

475mm

1322mm

FSL132210\*\*\*08\*\*\*

1000mm

475mm

1322mm

### 1017mm High Side Filer Storage.

3x 12" (305mm) drawers.

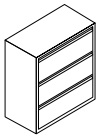

WIDTH



DEPTH



HEIGHT

FSL101708\*\*\*11\*\*\*

800mm

475mm

1017mm

FSL101710\*\*\*11\*\*\*

1000mm

475mm

1017mm

## /with mfc top

### 740mm High Side Filer Storage with MFC Top.

2x 12" (305mm) drawers.

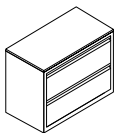

WIDTH



DEPTH



HEIGHT

FSL074008\*\*\*22\*\*\*

800mm

475mm

740mm

FSL074010\*\*\*22\*\*\*

1000mm

475mm

740mm

### 720mm High Side Filer Storage with MFC Top.

2x 12" (305mm) drawers.

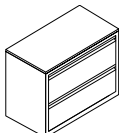

WIDTH



DEPTH



HEIGHT

FSL072008\*\*\*12\*\*\*

800mm

475mm

720mm

FSL072010\*\*\*12\*\*\*

1000mm

475mm

720mm

# freestor combination storage

## HOW TO SPECIFY A FREESTOR COMBINATION STORAGE

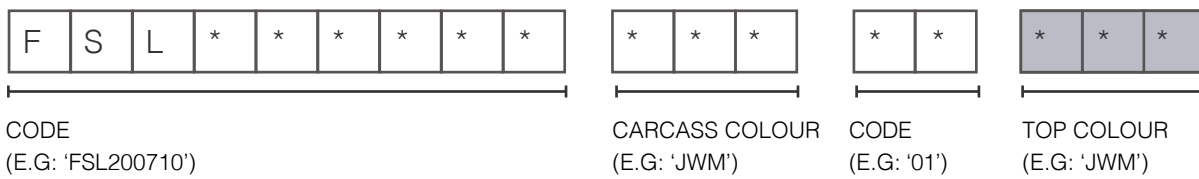

For example, to specify an all white 1000mm (w) x 475mm (d) x 2007mm (h) combination storage unit the code would be FSL200710JWM01JWM. When ordering a combination storage unit consider storage filing rails and shelving. All drawers are finished in black inside. It is compulsory that a counterbalance weight is ordered when more than one pull out drawer is fitted.

**IMPORTANT NOTE:** Combination Storage is all steel with a MFC top as an option. If a steel top is required select the desired steel colour in the \*\*\* section labelled 'Top Colour'. If an MFC top is required select in an MFC colour. MFC tops incur an additional cost.

### Steel Finishes

Black, Matt	BLM	Patina Green, Matt	GAM
Graphite Grey, Matt	GGM	Pale Green, Matt	GCM
Jot Silver, Matt	JOM	Sapphire Blue, Matt	USM
Pale Grey, Matt	PGM	Violet Blue, Matt	UVM
White, Matt	JWM	Distant Blue, Matt	UDM
Pale Brown, Matt	BPM	Pastel Blue, Matt	UPM
Grey Beige, Matt	BGM	Purple Red, Matt	RPM
Beige, Matt	BBM	Red Violet, Matt	RYM
Light Ivory, Matt	BIM	Orient Red, Matt	ROM
Olive Green, Matt	GOM	Beige Red, Matt	RBM
Fern Green, Matt	GFM	Tomato Red, Matt	RTM
Reed Green, Matt	GRM	Salmon Pink, Matt	PSM
Black Green, Matt	GBM	Yellow Orange, Matt	OYM
Pine Green, Matt	GPM	Broom Yellow, Matt	YBM

### Band 1 MFC Finishes

White	WHM
White/ Oak Edge	WHO
White/ Black Edge	WHB
Pale Grey	MOG
Dust Grey	DGM
Light Oak*	MOK*
Walnut*	MOW*

*\*Please note, we cannot guarantee continuity of these finishes.*

### Band 2 MFC Finishes

Cashmere Grey	MSC
Antique Rose	MAR
Reed Green	MRG
Denim Blue	MDB
Hamilton Oak	MHO
Nebraska Oak	MNO
Truffle Brown Oak	MDO
Natural Carini Walnut	MCW
Sevilla Ash	MSA
Chicago Concrete	MCC

# freestor combination storage

Note: Side filers require a counterbalance weight.

## 2007mm High Combination Storage.

3x 12" (305mm) drawers and 39" (990mm) hinged doors. Internal height: 1890mm

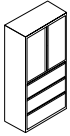

WIDTH



DEPTH



HEIGHT

FSL200708\*\*\*01\*\*\*

800mm

475mm

2007mm

FSL200710\*\*\*01\*\*\*

1000mm

475mm

2007mm

## 2007mm High Combination Storage.

3x 12" (305mm) drawers and 3x 13" (330mm) flippers.

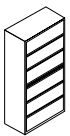

WIDTH



DEPTH



HEIGHT

FSL200708\*\*\*03\*\*\*

800mm

475mm

2007mm

FSL200710\*\*\*03\*\*\*

1000mm

475mm

2007mm

## 2007mm High Combination Storage.

4x 12" (305mm) drawers and 2x 13" (330mm) flippers plus shelf.

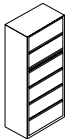

WIDTH



DEPTH



HEIGHT

FSL200708\*\*\*02\*\*\*

800mm

475mm

2007mm

FSL200710\*\*\*02\*\*\*

1000mm

475mm

2007mm

## 1677mm High Combination Storage.

3x 12" (305mm) drawers and 2x 13" (330mm) flippers.

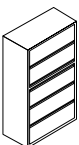

WIDTH



DEPTH



HEIGHT

FSL167708\*\*\*06\*\*\*

800mm

475mm

1677mm

FSL167710\*\*\*06\*\*\*

1000mm

475mm

1677mm

# Lateral components

Suitable for hinged door storage, combination storage and side filers

## Plain Shelf for Lateral Units.

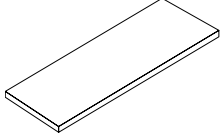

Available as a single (01) or pack of 6 (06). Filing height: 381mm/ 15" for foolscap lever arch files. 267mm/ 10.5" std. shelf files.



	WIDTH	FILING WIDTH	HEIGHT
<b>FSLCPLS0840BLS01</b>	800mm	748mm	13mm
<b>FSLCPLS082540BLS01</b>	825mm	773mm	13mm
<b>FSLCPLS1040BLS01</b>	1000mm	948mm	13mm
<b>FSLCPLS0840BLS06</b>	800mm	748mm	13mm
<b>FSLCPLS1040BLS06</b>	1000mm	948mm	13mm

## Slotted Filing Shelf for Lateral Units. (QTY: 01/04)

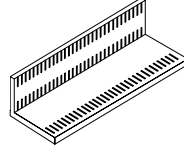
Available as a single (01) or pack of 4 (04). Filing height: As plain shelf information. + 343mm / 13.5" A4 lever arch files/ binders

	WIDTH	FILING WIDTH	HEIGHT
<b>FSLCFXS0840BLS01</b>	800mm	748mm	172mm
<b>FSLCFXS082540BLS01</b>	825mm	773mm	172mm
<b>FSLCFXS1040BLS01</b>	1000mm	948mm	172mm
<b>FSLCFXS0840BLS04</b>	800mm	748mm	172mm
<b>FSLCFXS1040BLS04</b>	1000mm	948mm	172mm

## Lateral Plain Shelf with Integral Suspension Rail for Lateral Units.

Available as a single (01) or pack of 4 (04). Fixed position. Filing height: 710mm or 28" total with lever arch files and AZV files.

	WIDTH	FILING WIDTH	HEIGHT
<b>FSLCULP0840BLS01</b>	800mm	748mm	23mm
<b>FSLCULP082540BLS01</b>	825mm	773mm	23mm
<b>FSLCULP1040BLS01</b>	1000mm	948mm	23mm
<b>FSLCULP0840BLS04</b>	800mm	748mm	23mm
<b>FSLCULP1040BLS04</b>	1000mm	948mm	23mm

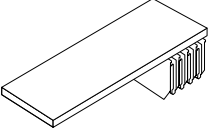
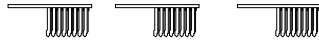
## Lateral Suspended Filing Rails for Lateral Units.

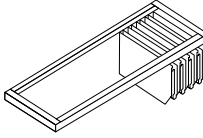
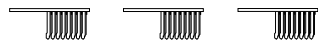

Available as a single (01) or pack of 6 (06). Filing height: 297mm with AZV files or 11" slots.

	WIDTH	FILING WIDTH	HEIGHT
<b>FSLCULR08RLBLS01</b>	800mm	748mm	23mm
<b>FSLCULR10RLBLS01</b>	1000mm	948mm	23mm
<b>FSLCULR08RLBLS06</b>	800mm	748mm	23mm
<b>FSLCULR10RLBLS06</b>	1000mm	948mm	23mm

## Side-to-Side Filing Rails for Drawers/ Lateral Units.

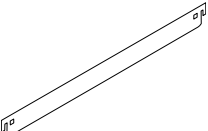

Available as a single (01) and a pack of 3 (03). 1 per drawer.

	WIDTH	FILING WIDTH / ROW	DEPTH
<b>FSLATFFS08SSBLS01</b>	800mm	748mm	N/a
<b>FSLATFFS10SSBLS01</b>	1000mm	948mm	N/a
<b>FSLATFFS08SSBLS03</b>	800mm	748mm	N/a
<b>FSLATFFS10SSBLS03</b>	1000mm	948mm	N/a

## Front-to-Back Filing Rails for Drawers/ Lateral Units.

Available as a single (01) and a pack of 3 (03). 1 per drawer.

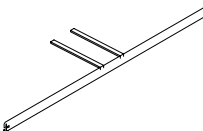
	WIDTH	FILING WIDTH / ROW	DEPTH
<b>FSLATFFS08FBLS01</b>	800mm	385mm x 2	N/a
<b>FSLATFFS10FBLS01</b>	1000mm	385mm x 2	N/a
<b>FSLATFFS08FBLS03</b>	800mm	385mm x 2	N/a
<b>FSLATFFS10FBLS03</b>	1000mm	385mm x 2	N/a

## Coat Shelf for Lateral Units.

Compatible with hinged door storage. 1 per unit.



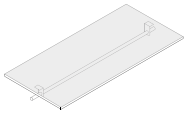
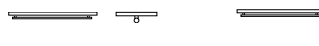

	WIDTH	DEPTH	HEIGHT
<b>FSLCCS0840***01</b>	800mm	25mm	23mm
<b>FSLCCS1040***01</b>	1000mm	25mm	23mm

# /accessories

## MFC Tops for Lateral Units.

Included on all 720mm and 740mm storage unless specified.



	WIDTH	DEPTH	HEIGHT
FSTOP0805***01	800mm	475mm	25mm
FSTOP1005***01	1000mm	475mm	25mm

## Sloping Tops for all Freestor units.

Suitable to be retro-fitted on site, sits on top of existing steel top.

Factory fitted slope tops require an SPT



	WIDTH	DEPTH	HEIGHT
FSUNISLOPE800***	800mm	475mm	150mm
FSUNISLOPE825***	825mm	475mm	150mm
FSUNISLOPE1000***	1000mm	475mm	150mm

## Shelf Dividers. (QTY: 05/15)

For use with slotted shelves. Filing height: 229mm or 9" slots.

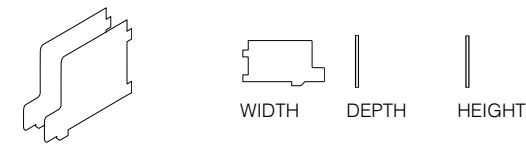

	WIDTH	DEPTH	HEIGHT
FSCDIV1508***05	5mm	380mm	200mm
FSCDIV1508***15	5mm	380mm	200mm

## Pigeon Holes. (Need to order slotted shelf and FSCDIV1508BLS).

Order 3 per 800mm shelf with 4 dividers, 4 per 1000mm shelf with 5 dividers. For Tambours order 2 per 800mm shelf with 3 dividers and 3 per 1000mm with 4 dividers. Filing height: 229mm or 9" slots.

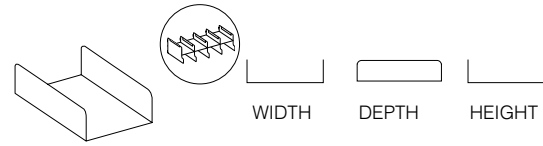

	WIDTH	DEPTH	HEIGHT
SCFPHUA4FLBLS04	226mm	330mm	100mm

## Counterbalance Weights.

Recommended if Freestor lateral unit contain 1 or more drawers.



	WIDTH	DEPTH	HEIGHT
FSTORBAL08	800mm	N/a	N/a
FSTORBAL10	1000mm	N/a	N/a

# freestor tambour storage

## HOW TO SPECIFY A FREESTOR TAMBOUR STORAGE

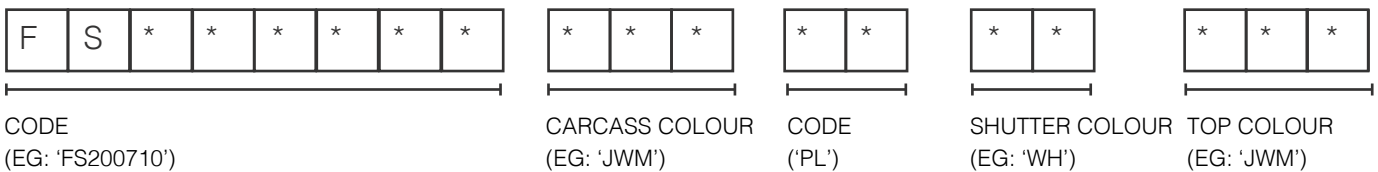

For example, to specify an all white 1000mm (w) x 475mm (d) x 2007mm (h) tambour storage unit the code would be FS200710JWMPLWHJWM. When ordering a tambour unit please consider various components.

Silver tambours may appear to shade slightly in certain lights, this is due to the manufacturing process and is unavoidable.

**IMPORTANT NOTE:** Tambour Storage is all steel with a MFC top as an option. If a steel top is required enter the desired steel colour in the section labelled 'Top Colour'. If an MFC top is required enter in an MFC colour. MFC tops incur an additional cost.

### Finishes

Black, Matt	BLM	Patina Green, Matt
Graphite Grey, Matt	GGM	Pale Green, Matt
Jot Silver, Matt	JOM	Sapphire Blue, Matt
Pale Grey, Matt	PGM	Violet Blue, Matt
White, Matt	JWM	Distant Blue, Matt
Pale Brown, Matt	BPM	Pastel Blue, Matt
Grey Beige, Matt	BGM	Purple Red, Matt
Beige, Matt	BBM	Red Violet, Matt
Light Ivory, Matt	BIM	Orient Red, Matt
Olive Green, Matt	GOM	Beige Red, Matt
Fern Green, Matt	GFM	Tomato Red, Matt
Reed Green, Matt	GRM	Salmon Pink, Matt
Black Green, Matt	GBM	Yellow Orange, Matt
Pine Green, Matt	GPM	Broom Yellow, Matt

### Tambour Shutter Finishes

Silver (Add 5%)	SL
Light Grey	LG
Dark Grey	DG
White	WH
Black	BK
<b>Band 1 MFC Finishes</b>	
White	WHM
White/ Oak Edge	WHO
White/ Black Edge	WHB
Pale Grey	MOG
Dust Grey	DGM
Light Oak*	MOK*
Walnut*	MOW*

### Band 2 MFC Finishes

Cashmere Grey	MSC
Antique Rose	MAR
Reed Green	MRG
Denim Blue	MDB
Hamilton Oak	MHO
Nebraska Oak	MNO
Truffle Brown Oak	MDO
Natural Carini Walnut	MCW
Sevilla Ash	MSA
Chicago Concrete	MCC

\*Please note, we cannot guarantee continuity of these finishes.

# freestor tambour storage /without mfc top

## 2007mm High Tambour Storage Unit.

Available in 800mm or 1000mm wide. Internal height: 1882mm

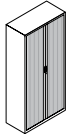

WIDTH



DEPTH



HEIGHT

FS200708\*\*\*PL\*\*\*\*

800mm

475mm

2007mm

FS200710\*\*\*PL\*\*\*\*

1000mm

475mm

2007mm

## 1677mm High Tambour Storage Unit.

Available in 800mm or 1000mm wide. Internal height: 1532mm

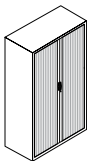

WIDTH



DEPTH



HEIGHT

FS167708\*\*\*PL\*\*\*\*

800mm

475mm

1677mm

FS167710\*\*\*PL\*\*\*\*

1000mm

475mm

1677mm

## 1322mm High Tambour Storage Unit.

Available in 800mm or 1000mm wide. Internal height: 1197mm

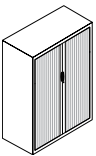

WIDTH



DEPTH



HEIGHT

FS132208\*\*\*PL\*\*\*\*

800mm

475mm

1322mm

FS132210\*\*\*PL\*\*\*\*

1000mm

475mm

1322mm

## 1200mm High Tambour Storage Unit.

Available in 800mm or 1000mm wide. Internal height: 1075mm

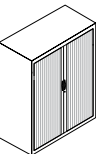

WIDTH



DEPTH



HEIGHT

FS120008\*\*\*PL\*\*\*\*

800mm

475mm

1200mm

FS120010\*\*\*PL\*\*\*\*

1000mm

475mm

1200mm

## 1017mm High Tambour Storage Unit.

Available in 800mm or 1000mm wide. Internal height: 882mm

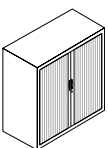

WIDTH



DEPTH



HEIGHT

FS101708\*\*\*PL\*\*\*\*

800mm

475mm

1017mm

FS101710\*\*\*PL\*\*\*\*

1000mm

475mm

1017mm

# /with mfc top

## 1110mm High Tambour Storage Unit with MFC Top.

Available in 800mm, 825mm or 1000mm wide. Internal height: 975mm.

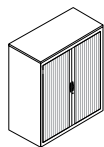

WIDTH



DEPTH



HEIGHT

FS111008***PL****	800mm	475mm	1110mm
FS11100825***PL****	825mm	475mm	1110mm
FS111010***PL****	1000mm	475mm	1110mm

## 1090mm High Tambour Storage Unit with MFC Top.

Available in 800mm, 825mm or 1000mm wide. Internal height: 955mm.

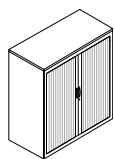

WIDTH



DEPTH



HEIGHT

FS109008***PL****	800mm	475mm	1090mm
FS10900825***PL****	825mm	475mm	1090mm
FS109010***PL****	1000mm	475mm	1090mm

## 740mm High Tambour Storage Unit with MFC Top.

Available in 800mm, 825mm or 1000mm wide. Internal height: 605mm.

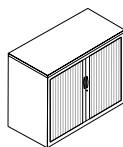

WIDTH



DEPTH



HEIGHT

FS074008***PL****	800mm	475mm	740mm
FS07400825***PL****	825mm	475mm	740mm
FS074010***PL****	1000mm	475mm	740mm

## 720mm High Tambour Storage Unit with MFC Top.

Available in 800mm, 825mm or 1000mm wide. Internal height: 605mm.

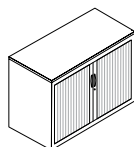

WIDTH



DEPTH



HEIGHT

FS072008***PL****	800mm	475mm	720mm
FS07200825***PL****	825mm	475mm	720mm
FS072010***PL****	1000mm	475mm	720mm



# freestor tambour wardrobe storage

## 2007mm High Tambour Coat Storage Unit.

Ventilated back. Comes with 1 fitted adjustable shelf. Order hangers separately (5 or 10 pack).

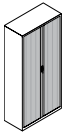

WIDTH



DEPTH



HEIGHT

FSROBE08 *** PL ** **	800mm	600mm	2007mm
FSROBE10 *** PL ** **	1000mm	600mm	2007mm

### Hangers

HANGERPACK05	N/A	N/A	N/A
HANGERPACK10	N/A	N/A	N/A

# /tambour components

## Plain Shelf for Tambours.

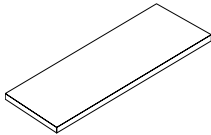

Available as a single (01) or pack of 6 (06). Filing height: 381mm/ 15" for foolscap lever arch files. 267mm/ 10.5" std. shelf files.



	WIDTH	FILING WIDTH	HEIGHT
<b>FSCPLS0840***01</b>	800mm	657mm	13mm
<b>FSCPLS082540***01</b>	825mm	682mm	13mm
<b>FSCPLS1040***01</b>	1000mm	857mm	13mm
<b>FSCPLS0840***06</b>	800mm	657mm	13mm
<b>FSCPLS1040***06</b>	1000mm	857mm	13mm

## Slotted Filing Shelf for Tambours. (QTY: 01/04)

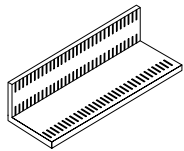

Available as a single (01) or pack of 4 (04). Filing height: As plain shelf information. + 343mm / 13.5" A4 lever arch files/ binders.

	WIDTH	FILING WIDTH	HEIGHT
<b>FSCFXS0840***01</b>	800mm	657mm	172mm
<b>FSCFXS082540***01</b>	825mm	682mm	172mm
<b>FSCFXS1040BLS01</b>	1000mm	857mm	172mm
<b>FSCFXS0840BLS04</b>	800mm	657mm	172mm
<b>FSCFXS1040BLS04</b>	1000mm	857mm	172mm

## Lateral Suspended Filing Rails for Tambours.

Available as a single (01) or pack of 6 (06). Filing height: 297mm with AZV files or 11" slots.

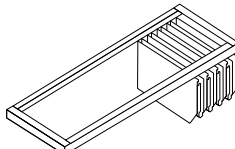
	WIDTH	FILING WIDTH	HEIGHT
<b>FSCULR08RLBLS01</b>	800mm	657mm	23mm
<b>FSCULR10RLBLS01</b>	1000mm	857mm	23mm
<b>FSCULR08RLBLS06</b>	800mm	657mm	23mm
<b>FSCULR10RLBLS06</b>	1000mm	857mm	23mm

## Lateral Plain Shelf with Integral Suspension Rail for Tambours.

Available as a single (01) or pack of 4 (04). Fixed position. Filing height: 710mm or 28" total with lever arch files and AZV files.

	WIDTH	FILING WIDTH	HEIGHT
<b>FSCULP0840BLS01</b>	800mm	657mm	23mm
<b>FSCULP082540BLS01</b>	825mm	682mm	23mm
<b>FSCULP1040BLS01</b>	1000mm	857mm	23mm
<b>FSCULP0840BLS04</b>	800mm	657mm	23mm
<b>FSCULP1040BLS04</b>	1000mm	857mm	23mm

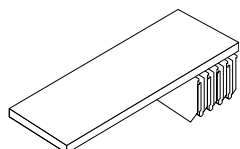
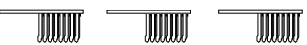
## Pull Out Shelf for Tambours.

Compatible with tambour storage. Filing height: 76mm OR 3"

	WIDTH	DEPTH	HEIGHT
<b>FSCPORS0840***01</b>	800mm	405mm	16mm
<b>FSCPORS1040***01</b>	1000mm	405mm	16mm

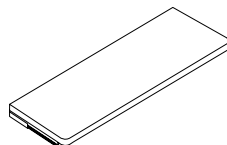
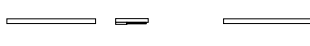
## Pull Out File Frame with 2 AR Rails for Tambours.

Inc. anti-tilt bars at 10.5" centres. For filing Front-to-Back, the filing width is 385mm per row, 2 rows. (385mm x 2). Filing height: 267mm or 10.5"

	WIDTH	FILING WIDTH	HEIGHT
<b>FSCUPF08AR***01</b>	800mm	620mm	42mm
<b>FSCUPF10AR***01</b>	1000mm	820mm	42mm

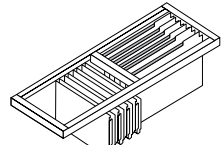
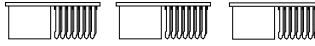
## System Drawer (Single) for Tambours. ONLY 1 PER UNIT

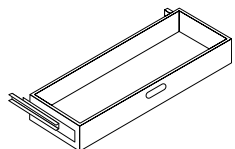
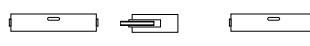

Compatible with tambour storage. Filing height: 178mm or 6" slots. Only one of these drawers are allowed per unit.

	WIDTH	DEPTH	HEIGHT
<b>FSCSYD0840***01</b>	800mm	410mm	100mm
<b>FSCSYD1040***01</b>	1000mm	410mm	100mm

## System Drawer Dividers. (QTY: 5)

Divides up the drawer creating compartments.

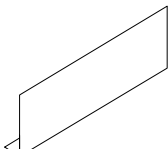
	WIDTH	DEPTH	HEIGHT
<b>FSCSDD4009***05</b>	95mm	5mm	408mm

**System Drawer at 11" Centres with Anti-tilt for Tambours. 2+ /UNIT**

Compatible with tambour storage. Includes anti tilt bars.  
Suitable for dental record cards. Filing height: 279mm or 11" slots.  
Use 2 or more of these drawers per unit.

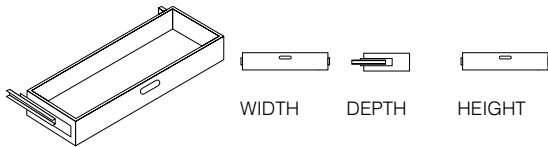

	WIDTH	DEPTH	HEIGHT
<b>FSCSYD084011***01</b>	800mm	410mm	100mm
<b>FSCSYD104011***01</b>	1000mm	410mm	100mm

**System Drawer at 8" Centres with Anti-tilt for Tambours. 2+ /UNIT**

Compatible with tambour storage. Includes anti tilt bars.  
Suitable for medical record cards. Filing height: 203mm or 8" slots.  
Use 2 or more of these drawers per unit.

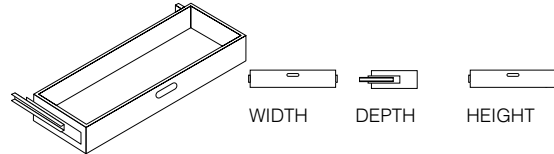

	WIDTH	DEPTH	HEIGHT
<b>FSCSYD084008***01</b>	800mm	410mm	100mm
<b>FSCSYD104008***01</b>	1000mm	410mm	100mm

**Coat Shelf for Tambours.**

Compatible with tambour units. 1 per unit.

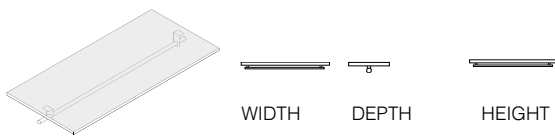

	WIDTH	DEPTH	HEIGHT
<b>FSCCS0840***01</b>	800mm	25mm	23mm
<b>FSCCS1040***01</b>	1000mm	25mm	23mm

**Long Rail to create Side-to-Side A4 Suspended Filing on UPF**

**for Tambours.** Filing width 620mm (800mm) and 820mm (1000mm).  
Filing height: 267mm or 10.5" slots

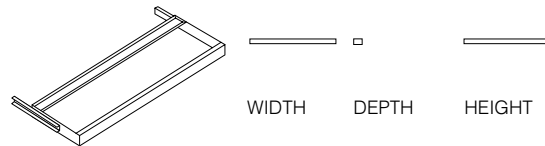

	WIDTH	DEPTH	HEIGHT
<b>FSCFLOR08***01</b>	800mm	70mm	12mm
<b>FSCFLOR10***01</b>	1000mm	70mm	12mm

# /tambour accessories

**MFC Tops for Tambour Units.**

Included on all 720mm and 740mm storage unless specified.

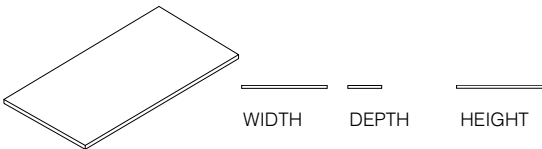

	WIDTH	DEPTH	HEIGHT
<b>FSCTOP0805***01</b>	800mm	475mm	25mm
<b>FSCTOP1005***01</b>	1000mm	475mm	25mm

**Sloping Tops for all Freestor units.**

Suitable to be retro-fitted on site, sits on top of existing steel top.  
Factory fitted slope tops require an SPT

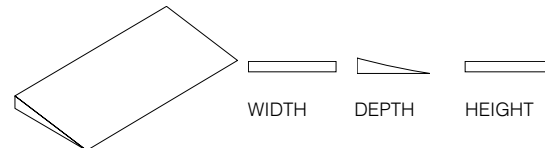

	WIDTH	DEPTH	HEIGHT
<b>FSUNISLOPE800***</b>	800mm	475mm	150mm
<b>FSUNISLOPE825***</b>	825mm	475mm	150mm
<b>FSUNISLOPE1000***</b>	1000mm	475mm	150mm

**Shelf Dividers. (QTY: 05/15)**

For use with slotted shelves. Filing height: 229mm or 9" slots.

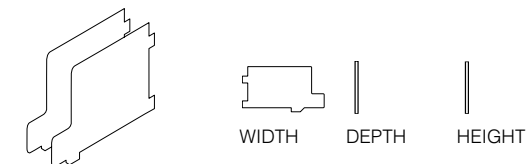

	WIDTH	DEPTH	HEIGHT
<b>FSCDIV1508***05</b>	5mm	380mm	200mm
<b>FSCDIV1508***15</b>	5mm	380mm	200mm

**Pigeon Holes. (Need to order slotted shelf and FSCDIV1508BLS)**

Order 3 per 800mm shelf with 4 dividers, 4 per 1000mm shelf with 5 dividers. For Tambours order 2 per 800mm shelf with 3 dividers and 3 per 1000mm with 4 dividers. Filing height: : 229mm or 9" slots.

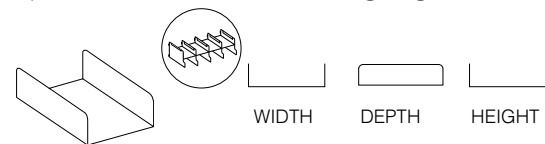

	WIDTH	DEPTH	HEIGHT
<b>SCFPHUA4FLBLS04</b>	226mm	330mm	100mm



# freestor accent lockers

## HOW TO SPECIFY A FREESTOR ACCENT LOCKER



CODE (For example: 'LKR6')      LABELS (Eg: 'A')      P. SLOT (Eg: 'C')      HINGES (Eg: 'D')      DRAWERS (Eg: 'E')      NUMBERING (Eg: 'F')      LOCK (Eg: 'G')      CABINET COLOUR (For example: 'JWM')      TOP COLOUR (For example: 'JWM')

For example, to specify an 8 door locker in all white finish, bottom drawers, post slots, soft close hinges and cam lock with silver plate. Locker: 800mm (w) x 475mm (d) x 1742mm (h), the code would be LKR4CDEHJWMJWM. This range is designed to provide a flexible way of specifying lockers exactly how you want them. If no additional elements are required, move on to the next option. For example, if no labels are required, do not enter 'A' or 'B'; and move on to option 'C'. All interior shelves, trays, number plates are ordered separately. Some locks may need additional items such as cards and software.

If an MFC top is specified on units 1-6, add 10mm to the overall height.

**IMPORTANT NOTE: Locker Storage is all steel and can come with a MFC top.** If a steel top is required select the desired steel colour in the \*\*\* section labeled 'Top Colour'. If an MFC top is required select a MFC colour. MFC tops incur an additional cost.

### Finishes

Black, Matt	BLM	Patina Green, Matt	GAM
Graphite Grey, Matt	GGM	Pale Green, Matt	GCM
Jot Silver, Matt	JOM	Sapphire Blue, Matt	USM
Pale Grey, Matt	PGM	Violet Blue, Matt	UVM
White, Matt	JWM	Distant Blue, Matt	UDM
Pale Brown, Matt	BPM	Pastel Blue, Matt	UPM
Grey Beige, Matt	BGM	Purple Red, Matt	RPM
Beige, Matt	BBM	Red Violet, Matt	RYM
Light Ivory, Matt	BIM	Orient Red, Matt	ROM
Olive Green, Matt	GOM	Beige Red, Matt	RBM
Fern Green, Matt	GFM	Tomato Red, Matt	RTM
Reed Green, Matt	GRM	Salmon Pink, Matt	PSM
Black Green, Matt	GBM	Yellow Orange, Matt	OYM
Pine Green, Matt	GPM	Broom Yellow, Matt	YBM

### Band 1 MFC Finishes

White	WHM
White/ Oak Edge	WHO
White/ Black Edge	WHB
Pale Grey	MOG
Dust Grey	DGM
Light Oak*	MOK*
Walnut*	MOW*

*\*Please note, we cannot guarantee continuity of these finishes.*

### Band 2 MFC Finishes

Cashmere Grey	MSC
Antique Rose	MAR
Reed Green	MRG
Denim Blue	MDB
Hamilton Oak	MHO
Nebraska Oak	MNO
Truffle Brown Oak	MDO
Natural Carini Walnut	MCW
Sevilla Ash	MSA
Chicago Concrete	MCC

# freestor accent lockers

## /lockers

### 2150mm High Locker Storage.

10 individual lockers. Opening aperture width with the clearance between hinge knuckle and door stop.

	UNIT			COMPARTMENT			
	WIDTH	DEPTH	HEIGHT	OPENING APERTURE	INTERNAL WIDTH	INTERNAL DEPTH	INTERNAL HEIGHT
LKR2 *****	800mm	475mm	2150mm	300mm	356mm	450mm	380mm
LKR1 *****	1000mm	475mm	2150mm	400mm	456mm	450mm	380mm

### Lock.

You must order a type of lock. G-N



LOCK

G - N

G - N

### 1742mm High Locker Storage.

8 individual lockers. Opening aperture width with the clearance between hinge knuckle and door stop.

	UNIT			COMPARTMENT			
	WIDTH	DEPTH	HEIGHT	OPENING APERTURE	INTERNAL WIDTH	INTERNAL DEPTH	INTERNAL HEIGHT
LKR4 *****	800mm	475mm	1742mm	300mm	356mm	450mm	380mm
LKR3 *****	1000mm	475mm	1742mm	400mm	456mm	450mm	380mm

### Lock.

You must order a type of lock. G-N



LOCK

G - N

G - N

### 1332mm High Locker Storage.

6 individual lockers. Opening aperture width with the clearance between hinge knuckle and door stop.

	UNIT			COMPARTMENT			
	WIDTH	DEPTH	HEIGHT	OPENING APERTURE	INTERNAL WIDTH	INTERNAL DEPTH	INTERNAL HEIGHT
LKR6 *****	800mm	475mm	1332mm	300mm	356mm	450mm	380mm
LKR5 *****	1000mm	475mm	1332mm	400mm	456mm	450mm	380mm

### Lock.

You must order a type of lock. G-N



LOCK

G - N

G - N

### 1110mm High Locker Storage with MFC Top.

6 individual lockers. Opening aperture width with the clearance between hinge knuckle and door stop.

	UNIT			COMPARTMENT			
	WIDTH	DEPTH	HEIGHT	OPENING APERTURE	INTERNAL WIDTH	INTERNAL DEPTH	INTERNAL HEIGHT
LKR8 *****	800mm	475mm	1110mm	300mm	356mm	450mm	302mm
LKR7 *****	825mm	475mm	1110mm	312mm	368mm	450mm	302mm

### Lock.

You must order a type of lock. G-N



LOCK

G - N

G - N

# /lock & feature options

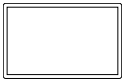

**Small Label Holder.** Black. In stock. Card insert. Size: 29mm x 50mm. Self adhesive (factory fitted).

**A**



**Large Label Holder.** Black. In stock. Card insert. Size: 55mm x 90mm. Self adhesive (factory fitted).

**B**



**Post Slot.** 25mm (h). 245mm or 305mm wide depending upon unit. Doors Only.

**C**



**Soft Close Hinge.** Closes softer reducing noise. Better for office environments.

**D**

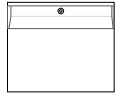

**Locking Bottom Drawer**  
Replaces bottom lockers with drawers. Key lock. Available on LKR1-6 lockers. 288 (h) x 400mm (d) x various widths.

**E**



**Compartment No.** Order number plates separately via SPB. 30mm holes only.

**F**



**Cam Lock.** Standard 90 degree cam lock. Supplied with 2 keys. In stock.

**G**



**Cam Lock + Name Plate.** Cam lock (left) plus silver name plate. Card insert size 35mm x 50mm

**H**

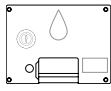

**Coin-Op Return.** Available right (07410-01) or left handed (07410-02). Accepts £1 or 1€. Master key inc., 700+ options. Unsuitable for wet areas.

**K**

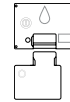

**Coin-Op Deposit.** Coin op return (as left) + lockable metal cash deposit box.

**L**

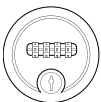

**C4 Black Combination Lock.** From stock.

**P**

ZHWLOCK142

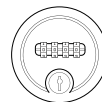

**C4 White Combination Lock.** From stock.

**Q**

ZHWLOCK142

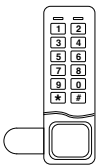

**MK731 Mini Digital Lock.** Ordered to demand. Public multi-user mode as standard.

**R**

ZHWLOCK175-MASTER



**MK729 Eco RFID Lock.** Ordered to demand. Public multi-user mode as standard.

**REQUEST SPT**

Minimum 1 card required  
Minimum 2 cards required  
Minimum 100 cards required

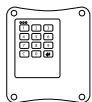

**Ronis Tronic Pro.** Access via 4-digit code. Code erased after lock opened for new user. 4x AA batteries (30,000 cycles). To supply programme keys to operate locks, each site needs to be recorded with each order placed.

**REQUEST SPT**

ZHWMISCBAT01

Master Key



**Ronis Rfid Mifare**

RFID Classic Mifare 1K/4K (ISO1443A/B). Integrability with Mifare Desfire. Mod multi user/ single user. Dry or wet applications.

**REQUEST SPT**

Management Card (Compulsory x1)  
Master Card (Compulsory x2)  
Software  
Battery Pack  
User Card\*  
User Wristband\*

\*Optional depending on end user. End user may already have their own card/wristbands - subject to compatibility.

# /accessories

## Adjustable Shelves.

2 pack.

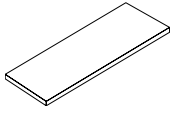

CARCASS  
WIDTH

LKR800SHELF02 ***	800mm
LKR825SHELF02 ***	825mm
LKR1000SHELF02 ***	1000mm

## Removable Tray.

Brackets included.

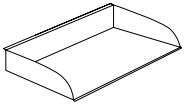

CARCASS  
WIDTH

LKR800TRAY02 ***	800mm
LKR825TRAY02 ***	825mm
LKR1000TRAY02 ***	1000mm



# metal lockers

## HOW TO SPECIFY METAL LOCKERS



CODE  
(For example: 'ASG1PL3318')

CARCASS COLOUR  
(For example: 'JWM')

DOOR COLOUR  
(For example: 'GGM')

CODE  
(EG: 'G')

LOCK  
(EG: 'C')

For example, to specify a single 1 door 300mm (w) x 300mm (d) x 1800mm (h) locker with a white carcass and graphite grey doors, the code would be ASG1PL3318JWMGGMGC.

Standard units come with a camlock or padlockable lock (padlock not included) at no extra cost. If an alternative lock is desired an extra cost will be added. Lock options include coin return locks, electronic, 4 digit combination locks and two point locking handles. Please contact Flexiform for advice on 01274 706 206.

300mm lockers have an opening aperture of 237mm.

450mm lockers have an opening aperture of 387mm.

### Finishes

Black, Matt	BLM	Black Green, Matt	GBM	Beige Red, Matt	RBM
Graphite Grey, Matt	GGM	Pine Green, Matt	GPM	Tomato Red, Matt	RTM
Jot Silver, Matt	JOM	Patina Green, Matt	GAM	Salmon Pink, Matt	PSM
Pale Grey, Matt	PGM	Pale Green, Matt	GCM	Yellow Orange, Matt	OYM
White, Matt	JWM	Sapphire Blue, Matt	USM	Broom Yellow, Matt	YBM
Pale Brown, Matt	BPM	Violet Blue, Matt	UVM		
Grey Beige, Matt	BGM	Distant Blue, Matt	UDM		
Beige, Matt	BBM	Pastel Blue, Matt	UPM		
Light Ivory, Matt	BIM	Purple Red, Matt	RPM		
Olive Green, Matt	GOM	Red Violet, Matt	RYM		
Fern Green, Matt	GFM	Orient Red, Matt	ROM		
Reed Green, Matt	GRM				

### Standard Lock Options

Padlockable Locks	P
Cam lock	C



# metal lockers

## Mild Steel Single Door Lockers.

With 2 lock options, 1 fixed shelf & 2 coat hooks.

Internal height is 1420mm below shelf, 253mm above the shelf. Without shelf 1694mm



WIDTH



DEPTH



HEIGHT



INTERNAL  
WIDTH



INTERNAL  
DEPTH



INTERNAL  
HEIGHT

ASG1PL3318 *** ** S *	300mm	300mm	1800mm	297mm	275mm	1694mm
ASG1PL3418 *** ** S *	300mm	450mm	1800mm	297mm	425mm	1694mm
ASG1PL4418 *** ** S *	450mm	450mm	1800mm	447mm	425mm	1694mm

## Mild Steel Two Door Lockers.

With 2 lock options and 4 coat hooks.



WIDTH



DEPTH



HEIGHT



INTERNAL  
WIDTH



INTERNAL  
DEPTH



INTERNAL  
HEIGHT

ASG2PL3318 *** ** S *	300mm	300mm	1800mm	297mm	275mm	834mm
ASG2PL3418 *** ** S *	300mm	450mm	1800mm	297mm	425mm	834mm
ASG2PL4418 *** ** S *	450mm	450mm	1800mm	447mm	425mm	834mm

## Mild Steel Three Door Lockers.

With 2 lock options.



WIDTH



DEPTH



HEIGHT



INTERNAL  
WIDTH



INTERNAL  
DEPTH



INTERNAL  
HEIGHT

ASG3PL3318 *** ** S *	300mm	300mm	1800mm	297mm	275mm	548mm
ASG3PL3418 *** ** S *	300mm	450mm	1800mm	297mm	425mm	548mm
ASG3PL4418 *** ** S *	450mm	450mm	1800mm	447mm	425mm	548mm

## Mild Steel Four Door Lockers.

With 2 lock options.

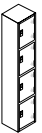

WIDTH



DEPTH



HEIGHT



INTERNAL  
WIDTH



INTERNAL  
DEPTH



INTERNAL  
HEIGHT

ASG4PL3318 *** ** S *	300mm	300mm	1800mm	297mm	275mm	404mm
ASG4PL3418 *** ** S *	300mm	450mm	1800mm	297mm	425mm	404mm
ASG4PL4418 *** ** S *	450mm	450mm	1800mm	447mm	425mm	404mm

# /accessories

## Sloping Tops for top of 1 Locker.

Sloping top per unit.

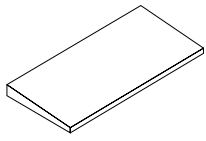

	WIDTH	DEPTH	HEIGHT
ASGSLTOP300300 ***	300mm	300mm	N/a
ASGSLTOP300450 ***	300mm	450mm	N/a
ASGSLTOP450450 ***	450mm	450mm	N/a

## Sloping Tops for top of Lockers.

Sloping top for 2 or 3 lockers

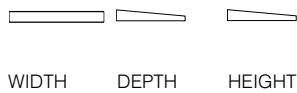
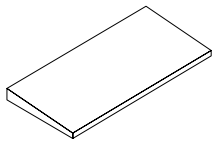

	WIDTH	DEPTH	HEIGHT
300mm x 300mm Lockers			
ASGSLTOP600300***	600mm	300mm	N/a
ASGSLTOP900300***	900mm	300mm	N/a
300mm x 450mm Lockers			
ASGSLTOP600450***	600mm	450mm	N/a
ASGSLTOP900450***	900mm	450mm	N/a
450mm x 450mm Lockers			
ASGSLTOP900450***	900mm	450mm	N/a

## Cladding Panel.

Covers up end of run and hides rivet heads.

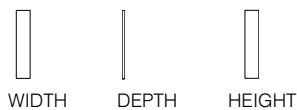

	WIDTH	DEPTH	HEIGHT
ASGCLAD300 ***	300mm	N/a	1800mm
ASGCLAD450 ***	450mm	N/a	1800mm





# luxo lockers

## HOW TO SPECIFY LUXO LOCKERS

Due to the large range of configurations, materials and finishes available, each Luxo Locker is created bespoke for the client. To specify your Luxo Locker, select the configuration, material, finishes, lock style and accessories and we'll create a preview example for your feedback.

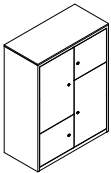

LOCKER PRICE IN  
RELATION TO COLOUR

+



LOCK PRICE PER  
DOOR QUANTITY

+

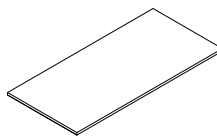

OPTIONAL MFC TOP

+

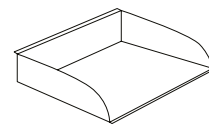

ACCESSORIES

Significant savings can be made for multiple units due to laminate sheet sizes.





### Finishes

Bio Carbon	See back of brochure for full colour range and code.
MFC	See back of brochure for full colour range and code.
Steel	See back of brochure for full colour range and code.

# luxo lockers

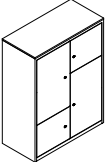



## 6 Door Luxo Locker in Laminate / MFC / Steel.

Luxo Locker in any door configuration. 1, 2 or 3 colour of Bio Carbon or MFC or any quantity of colour finishes in steel.

	COLOUR QTY	MAX DOOR	WIDTH	DEPTH	HEIGHT
					
Bio Carbon	1 - 3	Six	800mm	475mm	1317mm
MFC, Band 1	1 - 3	Six	800mm	475mm	1317mm
MFC, Band 2	1 - 3	Six	800mm	475mm	1317mm
Steel	Unlimited	Six	800mm	475mm	1317mm

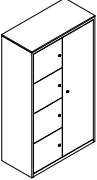
## 8 Door Luxo Locker in Laminate / MFC / Steel.

Luxo Locker in any door configuration. 1, 2 or 3 colour of Bio Carbon or MFC or any quantity of colour finishes in steel.

	COLOUR QTY	MAX DOOR	WIDTH	DEPTH	HEIGHT
					
Bio Carbon	1 - 3	Eight	800mm	475mm	1727mm
MFC, Band 1	1 - 3	Eight	800mm	475mm	1727mm
MFC, Band 2	1 - 3	Eight	800mm	475mm	1727mm
Steel	Unlimited	Eight	800mm	475mm	1727mm

# /locks

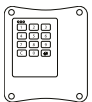

**Ronis Tronic Pro.** Access via 4-digit code. Code erased after lock opened for new user. 4x AA batteries (30,000 cycles). To supply programme keys to operate locks, each site needs to be recorded with each order placed.

**REQUEST SPT**  
ZHWMISCBAT01  
Master Key



### Ronis Rfid Mifare

RFID Classic Mifare 1K/4K (ISO1443A/B). Integrability with Mifare Desfire. Mod multi user/ single user. Dry or wet applications.

**REQUEST SPT**  
Management Card (Compulsory x1)  
Master Card (Compulsory x2)  
Software

Battery Pack

User Card\*

User Wristband\*

\*Optional depending on end user. End user may already have their own card/wristbands - subject to compatibility.



**Cam Lock.** Standard 90 degree cam lock. Supplied with 2 keys.

In stock.

**G**



**MK729 Eco RFID Lock.** Ordered to demand.

Public multi-user mode as standard.

**REQUEST SPT**  
Minimum 1 card required  
Minimum 2 cards required  
Minimum 100 cards required

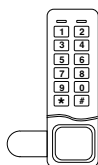

**MK731 Mini Digital Lock.** Ordered to demand.

Public multi-user mode as standard.

**R**  
ZHWLOCK175-MASTER

# /accessories

25mm MFC Locker Top

Nebraska Oak 25mm Locker Laminate Top

Small Label Holder

Large Label Holder

Single Steel Shelf

Single Steel Shelf with Handing Rail

# luxo lockers

## /up to 6 Door Locker

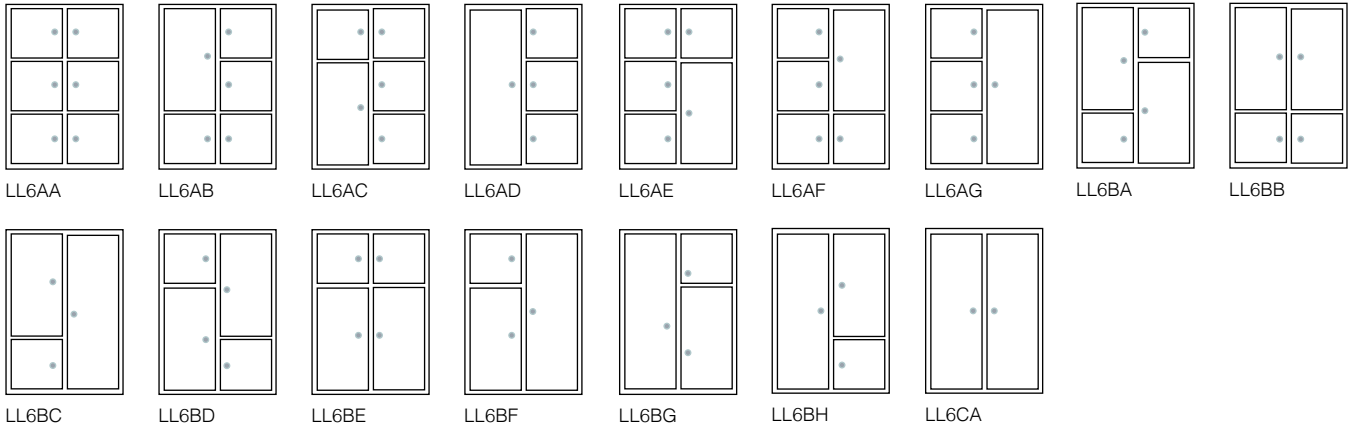

## /up to 8 Door Locker

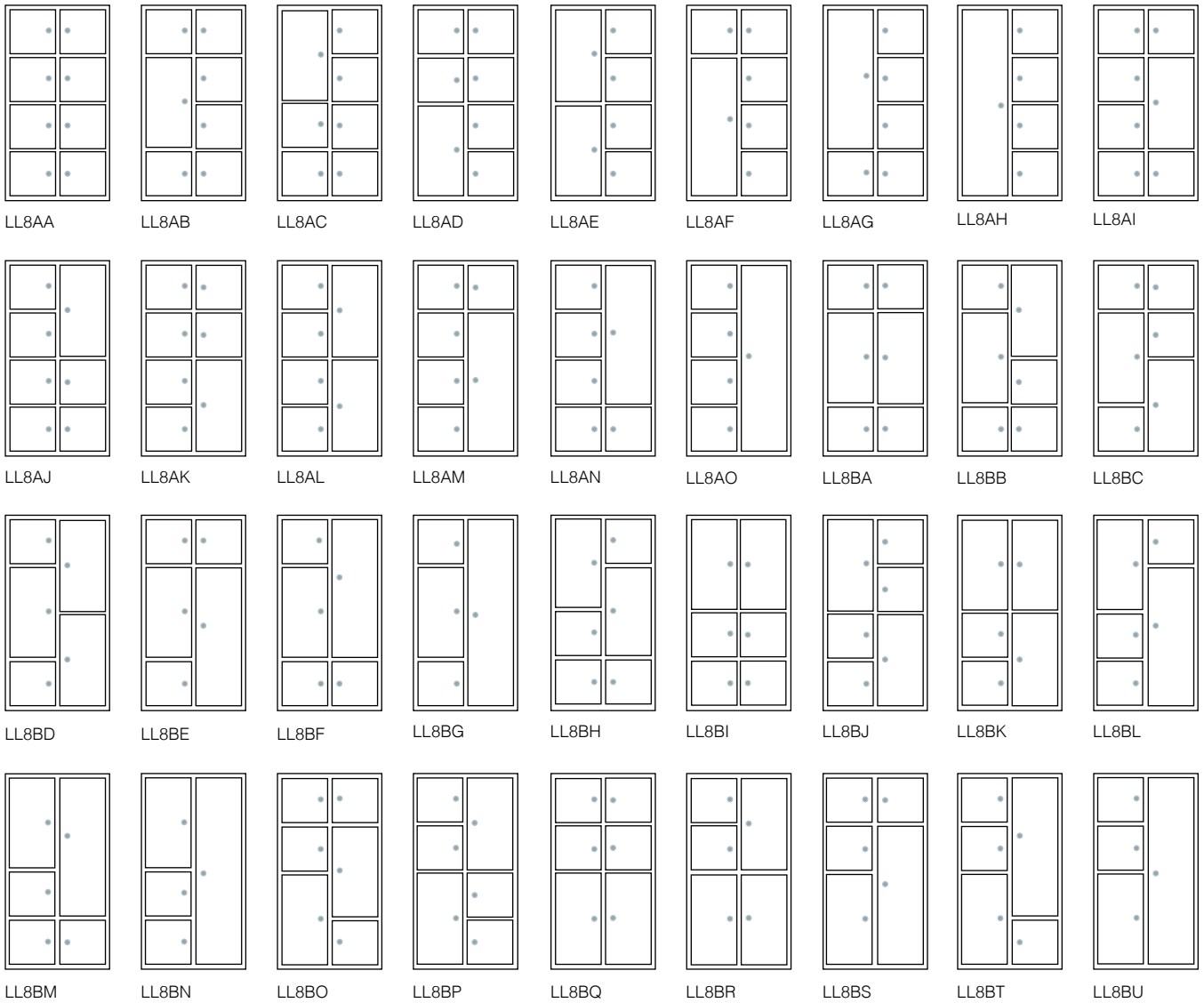

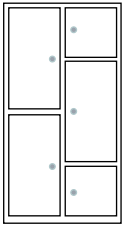

LL8BV

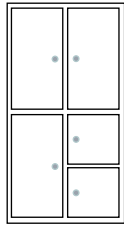

LL8BW

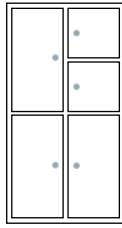

LL8BX

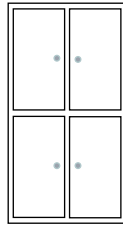

LL8BY

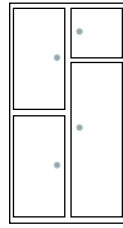

LL8BZ

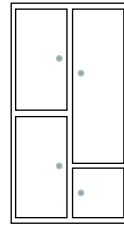

LL8BZA

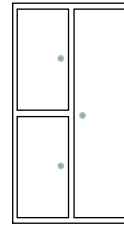

LL8BZB



LL8CA

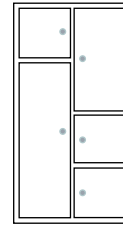

LL8CB

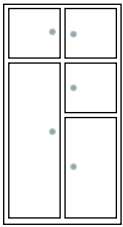

LL8CC

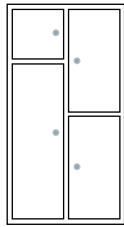

LL8CD

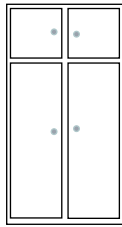

LL8CE

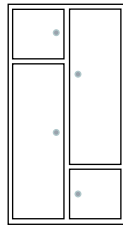

LL8CF

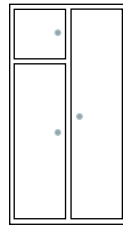

LL8CG

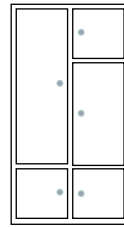

LL8CH

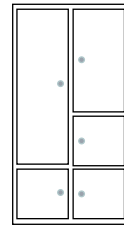

LL8CI

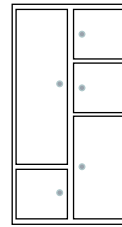

LL8CJ

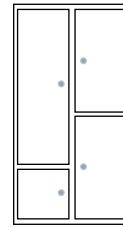

LL8CK

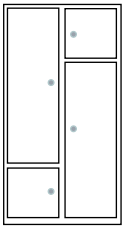

LL8CL



LL8CM

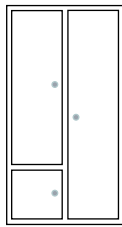

LL8CN

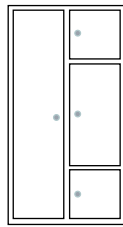

LL8DA

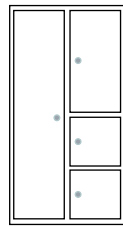

LL8DB

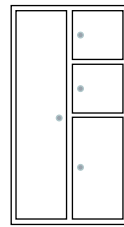

LL8DC

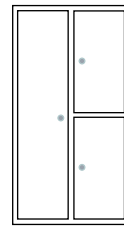

LL8DD



LL8DE



LL8DF

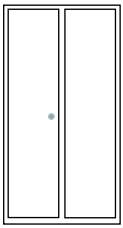

LL8DG



# flora & fauna

## HOW TO SPECIFY FLORA & FAUNA



CODE  
(E.G: 'PLANT' shown above)



SUITABILITY  
(E.G: 'INT')



WIDTH  
(E.G: '0825')

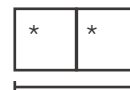

HEIGHT  
(E.G: '09')



STYLE  
(E.G: 'S')

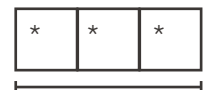

STEEL FINISH  
(E.G: 'BLM')

For example, to specify a Fauna interior slatted planter, 825mm wide to sit at the end of a back-to-back desk, in black (as above), the code would be PLANTINT082509SBLM.

Excludes compost, plants and horticultural advice. Counterbalance tray recommended to add a counterbalance weight. Please note, we do not recommend the Fauna slatted planters in light colour schemes due to the nature of the construction.

### Finishes

Black, Matt	BLM	Patina Green, Matt	GAM
Graphite Grey, Matt	GGM	Pale Green, Matt	GCM
Jot Silver, Matt	JOM	Sapphire Blue, Matt	USM
Pale Grey, Matt	PGM	Violet Blue, Matt	UVM
White, Matt	JWM	Distant Blue, Matt	UDM
Pale Brown, Matt	BPM	Pastel Blue, Matt	UPM
Grey Beige, Matt	BGM	Purple Red, Matt	RPM
Beige, Matt	BBM	Red Violet, Matt	RYM
Light Ivory, Matt	BIM	Orient Red, Matt	ROM
Olive Green, Matt	GOM	Beige Red, Matt	RBM
Fern Green, Matt	GFM	Tomato Red, Matt	RTM
Reed Green, Matt	GRM	Salmon Pink, Matt	PSM
Black Green, Matt	GBM	Yellow Orange, Matt	OYM
Pine Green, Matt	GPM	Broom Yellow, Matt	YBM



# flora & fauna

## Flora Internal Plain Freestanding Planter

Includes internal shallow tray. No drainage holes.

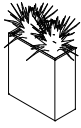

WIDTH



DEPTH\*



HEIGHT

PLANTINT080009P ***	800mm	350mm	900mm
PLANTINT082509P ***	825mm	350mm	900mm
PLANTINT100009P ***	1000mm	350mm	900mm

## Fauna Internal Slatted Freestanding Planter

Includes internal shallow tray. No drainage holes. Slats on 1 side.

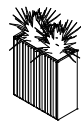

WIDTH



DEPTH\*



HEIGHT

PLANTINT080009S ***	800mm	350mm	900mm
PLANTINT082509S ***	825mm	350mm	900mm
PLANTINT100009S ***	1000mm	350mm	900mm

## Counterbalance Weight Tray

PLANTBALBPQ



# storage top planters

## HOW TO SPECIFY STORAGE TOP PLANTERS

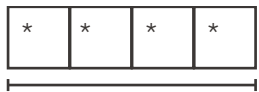

RANGE  
(E.G: 'FREE')



CODE  
(E.G: 'PLANT' shown above)

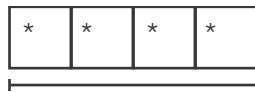

WIDTH  
(E.G: '0825')

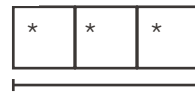

STEEL FINISH  
(E.G: 'BLM')

For example, to specify a black Freestor planter to suit a 825mm wide unit, the code would be FREEPLANT0825BLM.

Laser cut 20swg mild steel planter with folded assembly and spot weld corners. Self-aligning integrated corner on top face. Lined with a black damp proof membrane. Choice of powder coated colours from the standard Flexiform range. Excludes compost, plants and horticultural advice.

### Finishes

Black, Matt	BLM	Patina Green, Matt	GAM
Graphite Grey, Matt	GGM	Pale Green, Matt	GCM
Jot Silver, Matt	JOM	Sapphire Blue, Matt	USM
Pale Grey, Matt	PGM	Violet Blue, Matt	UVM
White, Matt	JWM	Distant Blue, Matt	UDM
Pale Brown, Matt	BPM	Pastel Blue, Matt	UPM
Grey Beige, Matt	BGM	Purple Red, Matt	RPM
Beige, Matt	BBM	Red Violet, Matt	RYM
Light Ivory, Matt	BIM	Orient Red, Matt	ROM
Olive Green, Matt	GOM	Beige Red, Matt	RBM
Fern Green, Matt	GFM	Tomato Red, Matt	RTM
Reed Green, Matt	GRM	Salmon Pink, Matt	PSM
Black Green, Matt	GBM	Yellow Orange, Matt	OYM
Pine Green, Matt	GPM	Broom Yellow, Matt	YBM

# storage top planters

## Freestor storage planters.

Sits on top of steel top storage.

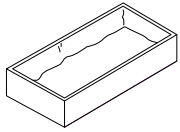

		
WIDTH	DEPTH	HEIGHT

FREEPLANT0800***	800mm	475mm	145mm
FREEPLANT0825***	825mm	475mm	145mm
FREEPLANT1000***	1000mm	475mm	145mm

## Metro storage planters.

Sits on top of steel top storage.

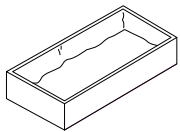

		
WIDTH	DEPTH	HEIGHT

METPLANT0800***	800mm	430mm	145mm
METPLANT0825***	825mm	430mm	145mm
METPLANT1000***	1000mm	430mm	145mm



RECYCLING POINT



recycling bins

## HOW TO SPECIFY RECYCLING BINS

R E C Y \* \* \* \*

TYPE OF BIN  
(E.G: 'RECYGRNL')

\* \* \*

STEEL COLOUR  
(E.G: 'GGM')

\* \* \*

STEEL COLOUR  
(E.G: 'JWM')

For example, to specify a general waste bin with white carcass, the code would be RECYGRNLGGMJWM.

### Finishes

Black, Matt	BLM	Patina Green, Matt	GAM
Graphite Grey, Matt	GGM	Pale Green, Matt	GCM
Jot Silver, Matt	JOM	Sapphire Blue, Matt	USM
Pale Grey, Matt	PGM	Violet Blue, Matt	UVM
White, Matt	JWM	Distant Blue, Matt	UDM
Pale Brown, Matt	BPM	Pastel Blue, Matt	UPM
Grey Beige, Matt	BGM	Purple Red, Matt	RPM
Beige, Matt	BBM	Red Violet, Matt	RYM
Light Ivory, Matt	BIM	Orient Red, Matt	ROM
Olive Green, Matt	GOM	Beige Red, Matt	RBM
Fern Green, Matt	GFM	Tomato Red, Matt	RTM
Reed Green, Matt	GRM	Salmon Pink, Matt	PSM
Black Green, Matt	GBM	Yellow Orange, Matt	OYM
Pine Green, Matt	GPM	Broom Yellow, Matt	YBM

# recycling bins

## Food Waste Recycling Bin with Fern Green Back Panel.

Rectangular aperture with removable bin and locking door.

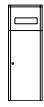
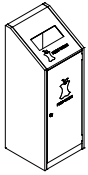

WIDTH

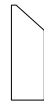

DEPTH



HEIGHT

RECYFOOD GFM \*\*\*

390mm

390mm

1050mm

## Paper Waste Recycling Bin with Violet Blue Back Panel.

Rectangular aperture with removable bin and locking door.

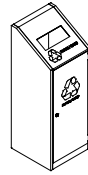

WIDTH



DEPTH



HEIGHT

RECYPAPR UVM \*\*\*

390mm

390mm

1050mm

## General Waste Recycling Bin with Graphite Grey Back Panel.

Rectangular aperture with removable bin and locking door.

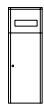
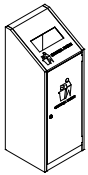

WIDTH



DEPTH



HEIGHT

RECYGNRL GGM \*\*\*

390mm

390mm

1050mm

## Plastic Recycling Bin with Red Violet Back Panel.

Rectangular aperture with removable bin and locking door.

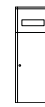
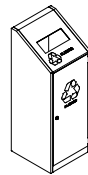

WIDTH



DEPTH



HEIGHT

RECYPLAS RLM \*\*\*

390mm

390mm

1050mm

## Confidential Recycling Bin with Tomato Red Back Panel.

Small slot aperture with removable bin and locking door.

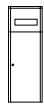
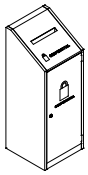

WIDTH



DEPTH



HEIGHT

RECYCONF RTM \*\*\*

390mm

390mm

1050mm



# credenza

## HOW TO SPECIFY CREDENZA



TOP CODE  
(E.G: 'CRED01')



STEEL  
(E.G: 'JWM')

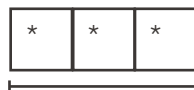

MFC  
(E.G: 'MOK')

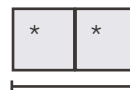

LEG  
(E.G: '74')

For example, to specify a 3 door credenza with hubless castors, white carcass and oak top, the code would be CRED01JWMMOK. Flexiform credenzas complete with internal components. (Please note, the above picture features a bespoke Fenix laminate).

### Steel Finishes

Black, Matt	BLM	Patina Green, Matt	GAM
Graphite Grey, Matt	GGM	Pale Green, Matt	GCM
Jot Silver, Matt	JOM	Sapphire Blue, Matt	USM
Pale Grey, Matt	PGM	Violet Blue, Matt	UVM
White, Matt	JWM	Distant Blue, Matt	UDM
Pale Brown, Matt	BPM	Pastel Blue, Matt	UPM
Grey Beige, Matt	BGM	Purple Red, Matt	RPM
Beige, Matt	BBM	Red Violet, Matt	RYM
Light Ivory, Matt	BIM	Orient Red, Matt	ROM
Olive Green, Matt	GOM	Beige Red, Matt	RBM
Fern Green, Matt	GFM	Tomato Red, Matt	RTM
Reed Green, Matt	GRM	Salmon Pink, Matt	PSM
Black Green, Matt	GBM	Yellow Orange, Matt	OYM
Pine Green, Matt	GPM	Broom Yellow, Matt	YBM

### Band 1 MFC Finishes

White	WHM
White/ Oak Edge	WHO
White/ Black Edge	WHB
Pale Grey	MOG
Dust Grey	DGM
Light Oak*	MOK*
Walnut*	MOW*

*\*Please note, we cannot guarantee continuity of these finishes.*

### Band 2 MFC Finishes

Cashmere Grey	MSC
Antique Rose	MAR
Reed Green	MRG
Denim Blue	MDB
Hamilton Oak	MHO
Nebraska Oak	MNO
Truffle Brown Oak	MDO
Natural Carini Walnut	MCW
Sevilla Ash	MSA
Chicago Concrete	MCC

# credenza

## /hubless castors

### 3 Door Credenza

Double door & single door compartment with 1x double shelf, 1x single shelf, hubless castors & push to open mechanism. 25mm MFC top.

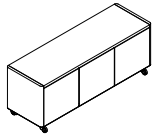

CRED01 \*\*\* \*\*



WIDTH

1600mm



DEPTH

515mm



HEIGHT

620mm

### 2 Door Credenza

Double door compartment with 1x double shelf, hubless castors and push to open mechanism. 25mm MFC top.



CRED02 \*\*\* \*\*



WIDTH

1088mm



DEPTH

515mm



HEIGHT

620mm

## /a' legs

### 4 Door Credenza

2x double door compartment with 2x double shelf, A legs and push to open mechanism. 25mm MFC top.

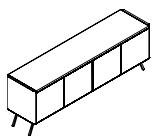

CRED06 \*\*\* \*\*74



WIDTH

2116mm



DEPTH

515mm



HEIGHT

740mm

### 3 Door Credenza

Double door and single door compartment with 1x double shelf, 1x single shelf, A legs and push to open mechanism. 25mm MFC top.

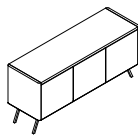

CRED01 \*\*\* \*\*74



WIDTH

1600mm



DEPTH

515mm



HEIGHT

740mm

### 2 Door Credenza

Double door compartment with 1x double shelf, A legs and push to open mechanism. 25mm MFC top.

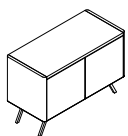

CRED02 \*\*\* \*\*74



WIDTH

1088mm



DEPTH

515mm



HEIGHT

740mm



# wood credenza

## HOW TO SPECIFY A WOOD CREDENZA



CODE  
(E.G: 'CREDCLAD' shown above)



DOOR SIZE  
(E.G: '3DR')

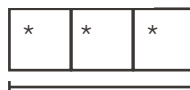

MFC CHOICE  
(E.G: 'MNO')

For example, to specify a 3 door credenza in standard MFC oak, the code would be 'CREDCLAD3DRMNO'.

### Band 1 MFC Finishes

White	WHM
Pale Grey	MOG
Dust Grey	DGM
Light Oak*	MOK*
Walnut*	MOW*

*\*Please note, we cannot guarantee continuity of these finishes.*

### Band 2 MFC Finishes

Cashmere Grey	MSC
Antique Rose	MAR
Reed Green	MRG
Denim Blue	MDB
Hamilton Oak	MHO
Nebraska Oak	MNO
Truffle Brown Oak	MDO
Natural Carini Walnut	MCW
Sevilla Ash	MSA
Chicago Concrete	MCC



# wood credenza

## 4 Door Wood Credenza

2 double doors, 1 shelf per compartment. Push to open door mechanism. All steel is black. Non-locking doors.

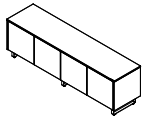

WIDTH DEPTH HEIGHT

CREDCLAD4DR \*\*\*

2096mm 515mm 640mm

## 3 Door Wood Credenza

1 double door, 1 single door, 1 shelf per compartment. Push to open door mechanism. All steel is black. Non-locking doors.

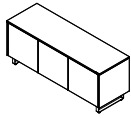

WIDTH DEPTH HEIGHT

CREDCLAD3DR \*\*\*

1580mm 515mm 640mm

## 2 Door Wood Credenza

1 double door, 1 shelf per compartment. Push to open door mechanism. All steel is black. Non-locking doors.

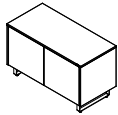

WIDTH DEPTH HEIGHT

CREDCLAD2DR \*\*\*

1069mm 515mm 640mm



flexilink

## HOW TO SPECIFY FLEXILINK



CODE  
(For example: 'FL2140ENDPLAIN')



COLOUR  
(For example: 'JWM')

For example, to specify an all white, 2 bay 2075mm wide x 350mm deep x 2175mm high single sided Flexilink unit, you would order: 2x FL2110SOLIDBACKJWM, 2x FL2135ENDPLAINJWM, 1x FL2135MIDPLAINJWM and a minimum of 1 pack of FLPS1035JWM04 (3 packs recommended. 12 shelves in total)

### Notes

- Flexilink cannot be used as a single unit, and must have a minimum of 2 bays.
- Ensure all single sided depths under 500mm are secured to a wall using Flexilink wall brackets.
- Shelves and back panels must be used to support the unit, however if two units are back-to-back only one back panel is used.
- Linking brackets are required for back to back units for health and safety reasons.
- When calculating floor space use the width of the shelves selected and add 25mm for every end or mid panel used.

### Finishes

Black, Matt	BLM	Black Green, Matt	GBM	Beige Red, Matt	RBM
Graphite Grey, Matt	GGM	Pine Green, Matt	GPM	Tomato Red, Matt	RTM
Jot Silver, Matt	JOM	Patina Green, Matt	GAM	Salmon Pink, Matt	PSM
Pale Grey, Matt	PGM	Pale Green, Matt	GCM	Yellow Orange, Matt	OYM
White, Matt	JWM	Sapphire Blue, Matt	USM	Broom Yellow, Matt	YBM
Pale Brown, Matt	BPM	Violet Blue, Matt	UVM		
Grey Beige, Matt	BGM	Distant Blue, Matt	UDM		
Beige, Matt	BBM	Pastel Blue, Matt	UPM		
Light Ivory, Matt	BIM	Purple Red, Matt	RPM		
Olive Green, Matt	GOM	Red Violet, Matt	RYM		
Fern Green, Matt	GFM	Orient Red, Matt	ROM		
Reed Green, Matt	GRM				

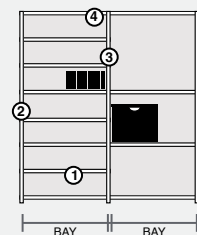

### Shelving Components

1. Back panels, 1 per bay
2. End panel, 2 needed per single sided unit. 4 per double sided unit.
3. Mid panels, as many as desired to create a bay
4. Shelves (pack of 4)

# flexilink /back panels

## Step 1. Order back panels.

- You must order 1 back panel per unit bay unless specifying back to back shelving. Back to back shelving unit bays share a back panel.
- All back panels must be the same height.

- Different widths can be ordered (but remember the different widths when it comes to ordering the shelves!).

### 2175mm High Plain Back Panels.

Select to create a 2175mm high Flexilink 555 Shelving System.



WIDTH



DEPTH



HEIGHT

FL2106SOLIDBACK***	600mm	N/a	2175mm
FL2108SOLIDBACK***	800mm	N/a	2175mm
FL2109SOLIDBACK***	900mm	N/a	2175mm
FL2110SOLIDBACK***	1000mm	N/a	2175mm
FL2112SOLIDBACK***	1200mm	N/a	2175mm

### 1875mm High Plain Back Panels.

Select to create a 1875mm high Flexilink 555 Shelving System.

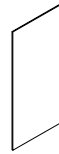

WIDTH



DEPTH



HEIGHT

FL1806SOLIDBACK***	600mm	N/a	1875mm
FL1808SOLIDBACK***	800mm	N/a	1875mm
FL1809SOLIDBACK***	900mm	N/a	1875mm
FL1810SOLIDBACK***	1000mm	N/a	1875mm
FL1812SOLIDBACK***	1200mm	N/a	1875mm

### 1575mm High Plain Back Panels.

Select to create a 1575mm high Flexilink 555 Shelving System.



WIDTH



DEPTH



HEIGHT

FL1506SOLIDBACK***	600mm	N/a	1575mm
FL1508SOLIDBACK***	800mm	N/a	1575mm
FL1509SOLIDBACK***	900mm	N/a	1575mm
FL1510SOLIDBACK***	1000mm	N/a	1575mm
FL1512SOLIDBACK***	1200mm	N/a	1575mm

### 1275mm High Plain Back Panels.

Select to create a 1275mm high Flexilink 555 Shelving System.



WIDTH



DEPTH



HEIGHT

FL1206SOLIDBACK***	600mm	N/a	1275mm
FL1208SOLIDBACK***	800mm	N/a	1275mm
FL1209SOLIDBACK***	900mm	N/a	1275mm
FL1210SOLIDBACK***	1000mm	N/a	1275mm
FL1212SOLIDBACK***	1200mm	N/a	1275mm

### 975mm High Plain Back Panels.

Select to create a 975mm high Flexilink 555 Shelving System.

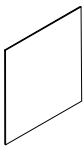

WIDTH



DEPTH



HEIGHT

FL0906SOLIDBACK***	600mm	N/a	975mm
FL0908SOLIDBACK***	800mm	N/a	975mm
FL0909SOLIDBACK***	900mm	N/a	975mm
FL0910SOLIDBACK***	1000mm	N/a	975mm
FL0912SOLIDBACK***	1200mm	N/a	975mm

# /end panels

## Step 2. Order end panels.

- You must order 2 end panels.
- The end panels must match the height of the back panels.

- The depth of the end panels selected defines the depth of your shelves.

### 2175mm High Plain End Panels.

Select to create a 2175mm high Flexilink 555 Shelving System.

	WIDTH	DEPTH	HEIGHT
FL2125ENDPLAIN***	25mm	250mm	2175mm
FL2130ENDPLAIN***	25mm	300mm	2175mm
FL2135ENDPLAIN***	25mm	350mm	2175mm
FL2140ENDPLAIN***	25mm	400mm	2175mm
FL2150ENDPLAIN***	25mm	500mm	2175mm
FL2160ENDPLAIN***	25mm	600mm	2175mm

### 1875mm High Plain End Panels.

Select to create a 1875mm high Flexilink 555 Shelving System.

	WIDTH	DEPTH	HEIGHT
FL1825ENDPLAIN***	25mm	250mm	1875mm
FL1830ENDPLAIN***	25mm	300mm	1875mm
FL1840ENDPLAIN***	25mm	400mm	1875mm
FL1850ENDPLAIN***	25mm	500mm	1875mm
FL1860ENDPLAIN***	25mm	600mm	1875mm

### 1575mm High End Panels.

Select to create a 1575mm high Flexilink 555 Shelving System.

	WIDTH	DEPTH	HEIGHT
FL1525ENDPLAIN***	25mm	250mm	1575mm
FL1530ENDPLAIN***	25mm	300mm	1575mm
FL1540ENDPLAIN***	25mm	400mm	1575mm
FL1550ENDPLAIN***	25mm	500mm	1575mm
FL1560ENDPLAIN***	25mm	600mm	1575mm

### 1275mm High End Panels.

Select to create a 1275mm high Flexilink 555 Shelving System.

	WIDTH	DEPTH	HEIGHT
FL1225ENDPLAIN***	25mm	250mm	1275mm
FL1230ENDPLAIN***	25mm	300mm	1275mm
FL1240ENDPLAIN***	25mm	400mm	1275mm
FL1250ENDPLAIN***	25mm	500mm	1275mm
FL1260ENDPLAIN***	25mm	600mm	1275mm

### 975mm High End Panels.

Select to create a 975mm high Flexilink 555 Shelving System.

	WIDTH	DEPTH	HEIGHT
FL0925ENDPLAIN***	25mm	250mm	975mm
FL0930ENDPLAIN***	25mm	300mm	975mm
FL0940ENDPLAIN***	25mm	400mm	975mm
FL0950ENDPLAIN***	25mm	500mm	975mm
FL0960ENDPLAIN***	25mm	600mm	975mm

# /mid panels

## Step 3. Order mid panels.

- A mid panel is needed inbetween each back panel. For example:  
'end panel' > 'back panel' > 'mid panel' > 'back panel' > 'end panel'

- The mid panels must match the height and depth of the end panels

### 2175mm High Plain Mid Panels.

Select to create a 2175mm high Flexilink 555 Shelving System.

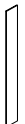
	WIDTH	DEPTH	HEIGHT
			
FL2125MIDPLAIN***	25mm	250mm	2175mm
FL2130MIDPLAIN***	25mm	300mm	2175mm
FL2135MIDPLAIN***	25mm	350mm	2175mm
FL2140MIDPLAIN***	25mm	400mm	2175mm
FL2150MIDPLAIN***	25mm	500mm	2175mm
FL2160MIDPLAIN***	25mm	600mm	2175mm

### 1875mm High Plain Mid Panels.

Select to create a 1875mm high Flexilink 555 Shelving System.

	WIDTH	DEPTH	HEIGHT
			
FL1825MIDPLAIN***	25mm	250mm	1875mm
FL1830MIDPLAIN***	25mm	300mm	1875mm
FL1840MIDPLAIN***	25mm	400mm	1875mm
FL1850MIDPLAIN***	25mm	500mm	1875mm
FL1860MIDPLAIN***	25mm	600mm	1875mm

### 1575mm High Plain Mid Panels.

Select to create a 1575mm high Flexilink 555 Shelving System.

	WIDTH	DEPTH	HEIGHT
			
FL1525MIDPLAIN***	25mm	250mm	1575mm
FL1530MIDPLAIN***	25mm	300mm	1575mm
FL1540MIDPLAIN***	25mm	400mm	1575mm
FL1550MIDPLAIN***	25mm	500mm	1575mm
FL1560MIDPLAIN***	25mm	600mm	1575mm

### 1275mm High Plain Mid Panels.

Select to create a 1275mm high Flexilink 555 Shelving System.

	WIDTH	DEPTH	HEIGHT
			
FL1225MIDPLAIN***	25mm	250mm	1275mm
FL1230EMIDPLAIN***	25mm	300mm	1275mm
FL1240MIDPLAIN***	25mm	400mm	1275mm
FL1250MIDPLAIN***	25mm	500mm	1275mm
FL1260MIDPLAIN***	25mm	600mm	1275mm

### 975mm High Plain Mid Panels.

Select to create a 975mm high Flexilink 555 Shelving System.

	WIDTH	DEPTH	HEIGHT
			
FL0925MIDPLAIN***	25mm	250mm	975mm
FL0930MIDPLAIN***	25mm	300mm	975mm
FL0940MIDPLAIN***	25mm	400mm	975mm
FL0950MIDPLAIN***	25mm	500mm	975mm
FL0960MIDPLAIN***	25mm	600mm	975mm

# /linking brackets & wall brackets

**Step 5.** Order linking bracket if specifying a back to back shelving system, or wall brackets if your single sided unit is <500mm deep

• Linking brackets for back to back shelving only. 1 linking bracket is needed at both ends of the Shelving and at the cross sections where 4 bays meet.

• Wall brackets for single sided units 500mm deep and under. Two wall brackets is needed per bay. Sold in pairs

**Linking Brackets (10).** Link two complete Flexilink 555 Shelving System back to back.

FLLINKBRKT10

**Wall Brackets (Pair).** Secures single sided 500mm deep and under units to walls.

FLWALLBRKT2\*\*\*

# /shelves

**Step 6.** Order shelves (All shelves come in packs of 4 with fixing clips)

• Shelves must be ordered to help secure the unit.  
• The shelves must match the width of the back panels AND the depth of the end and mid panels.

• You can mix and match with plain or slotted shelves.  
• You may want to order a shelf to create the top of the unit.  
• Units 500mm deep and under **MUST** be secured to the wall.

## 1200mm Width Plain Shelf.

To match 1200mm wide back panels.

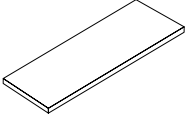

	WIDTH	DEPTH	HEIGHT
FLPS1202***04	1200mm	250mm	25mm
FLPS1203***04	1200mm	300mm	25mm
FLPS1204***04	1200mm	400mm	25mm
FLPS1205***04	1200mm	500mm	25mm
FLPS1206***04	1200mm	600mm	25mm

## 1200mm Width Slotted Shelf.

To match 1200mm wide back panels.

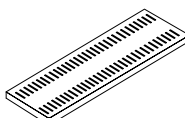

	WIDTH	DEPTH	HEIGHT
FLSS1202***04	1200mm	250mm	25mm
FLSS1203***04	1200mm	300mm	25mm
FLSS1204***04	1200mm	400mm	25mm
FLSS1205***04	1200mm	500mm	25mm
FLSS1206***04	1200mm	600mm	25mm

## 1000mm Width Plain Shelf.

To match 1000mm wide back panels.

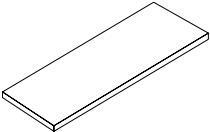

	WIDTH	DEPTH	HEIGHT
FLPS1002***04	1000mm	250mm	25mm
FLPS1003***04	1000mm	300mm	25mm
FLPS1035***04	1000mm	350mm	25mm
FLPS1004***04	1000mm	400mm	25mm
FLPS1005***04	1000mm	500mm	25mm
FLPS1006***04	1000mm	600mm	25mm

## 1000mm Width Slotted Shelf.

To match 1000mm wide back panels.

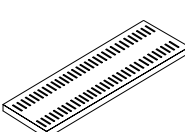

	WIDTH	DEPTH	HEIGHT
FLSS1002***04	1000mm	250mm	25mm
FLSS1003***04	1000mm	300mm	25mm
FLSS1004***04	1000mm	400mm	25mm
FLSS1005***04	1000mm	500mm	25mm
FLSS1006***04	1000mm	600mm	25mm

## 900mm Width Plain Shelf.

To match 900mm wide back panels.

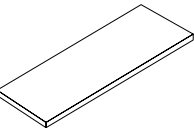

	WIDTH	DEPTH	HEIGHT
FLPS0902***04	900mm	250mm	25mm
FLPS0903***04	900mm	300mm	25mm
FLPS0904***04	900mm	400mm	25mm
FLPS0905***04	900mm	500mm	25mm
FLPS0906***04	900mm	600mm	25mm

## 900mm Width Slotted Shelf.

To match 900mm wide back panels.

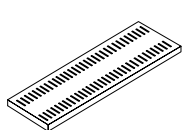

	WIDTH	DEPTH	HEIGHT
FLSS0902***04	900mm	250mm	25mm
FLSS0903***04	900mm	300mm	25mm
FLSS0904***04	900mm	400mm	25mm
FLSS0905***04	900mm	500mm	25mm
FLSS0906***04	900mm	600mm	25mm

### 800mm Width Plain Shelf.

To match 800mm wide back panels.



	WIDTH	DEPTH	HEIGHT
FLPS0802***04	800mm	250mm	25mm
FLPS0803***04	800mm	300mm	25mm
FLPS0835***04	800mm	350mm	25mm
FLPS0804***04	800mm	400mm	25mm
FLPS0805***04	800mm	500mm	25mm
FLPS0806***04	800mm	600mm	25mm

### 800mm Width Slotted Shelf.

To match 800mm wide back panels.



	WIDTH	DEPTH	HEIGHT
FLSS0802***04	800mm	250mm	25mm
FLSS0803***04	800mm	300mm	25mm
FLSS0804***04	800mm	400mm	25mm
FLSS0805***04	800mm	500mm	25mm
FLSS0806***04	800mm	600mm	25mm

### 600mm Width Plain Shelf.

To match 600mm wide back panels.



	WIDTH	DEPTH	HEIGHT
FLPS0602***04	600mm	250mm	25mm
FLPS0603***04	600mm	300mm	25mm
FLPS0604***04	600mm	400mm	25mm
FLPS0605***04	600mm	500mm	25mm
FLPS0606***04	600mm	600mm	25mm

### 600mm Width Slotted Shelf.

To match 600mm wide back panels.



	WIDTH	DEPTH	HEIGHT
FLPS0602***04	600mm	250mm	25mm
FLPS0603***04	600mm	300mm	25mm
FLPS0604***04	600mm	400mm	25mm
FLPS0605***04	600mm	500mm	25mm
FLPS0606***04	600mm	600mm	25mm

### Plain Shelf with Fixed Suspension Rails.

Only suitable for 400mm deep and 800 or 1000mm wide bays.

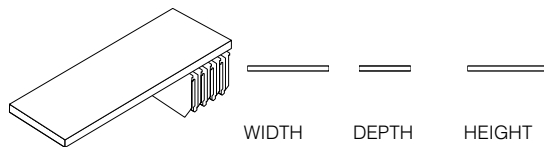

	WIDTH	DEPTH	HEIGHT
FCULP0840***01	800mm	400mm	25mm
FCULP1040***01	1000mm	400mm	25mm
FCULP0840***04	800mm	400mm	25mm
FCULP1040***04	1000mm	400mm	25mm

## /accessories

### Dividers for Plain Shelves (5).

To match depth of shelves selected.

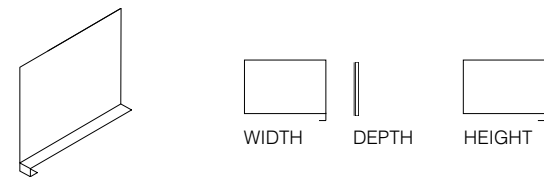

	WIDTH	DEPTH	HEIGHT
FLUNIDIV250***05	1.2mm	250mm	180mm
FLUNIDIV300***05	1.2mm	300mm	180mm
FLUNIDIV400***05	1.2mm	400mm	180mm
FLUNIDIV500***05	1.2mm	500mm	180mm
FLUNIDIV600***05	1.2mm	600mm	180mm

### Dividers for Slotted Shelves (5).

To match depth of shelves selected.

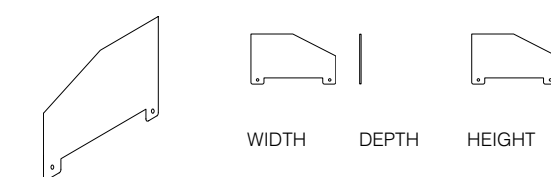

	WIDTH	DEPTH	HEIGHT
FLSLOTDIV250***05	1.2mm	250mm	180mm
FLSLOTDIV300***05	1.2mm	300mm	180mm
FLSLOTDIV400***05	1.2mm	400mm	180mm
FLSLOTDIV500***05	1.2mm	500mm	180mm
FLSLOTDIV600***05	1.2mm	600mm	180mm



flexigrid

## HOW TO SPECIFY FLEXIGRID

FlexiGrid is a multifunctional shelving system that can be tailored to your individual requirements. We've created 12 unique configurations as a reference point, more configurations can be created at [www.theconfigurator.uk](http://www.theconfigurator.uk)

### Tiers Heights

455mm, 855mm, 1255mm,  
1655mm and 2055mm.

### Blazer Lite Fabric Panels

Balance LTH41

Buddha LTH56

Cuddle LTH62

Dainty LTH64

Daydream LTH46

Devoted LTH58

Happy LTH55

Harmony LTH63

Haven LTH40

Mood LTH44

Retreat LLTH39

Solace LTH70

Tender LTH53

True LTH61

Wish TH67

Angel LTH49

Hope LTH50

### Steel

Anthracite, white, black, clear  
lacquer, reed green.

### MFC

Oak, white and graphite.



# flexigrid

## FlexiGrid Configuration 1.

Double width shelving with 1x single cubby, 1x double width cubby and 1x double width planter. Includes wall bracket.



FINISH

WIDTH

DEPTH

HEIGHT

FlexiGrid01

Oak/Black

820mm

420mm

2055mm

## FlexiGrid Configuration 2.

Double width shelving & cupboard. Wall bracket included.



FINISH

WIDTH

DEPTH

HEIGHT

FlexiGrid02

Oak/Black

820mm

420mm

2055mm

## FlexiGrid Configuration 3.

5x wide shelving with 7x single cubbies, 2x single planters. Wall bracket included.

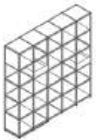

FINISH

WIDTH

DEPTH

HEIGHT

FlexiGrid03

White/Black

2020mm

420mm

2055mm

## FlexiGrid Configuration 4.

4x wide multi-tiered shelving with fabric infill panels and 2x single cubbies. Wall bracket included.



FINISH

WIDTH

DEPTH

HEIGHT

FlexiGrid04

White/ Oak/Black/Fabric

1620mm

420mm

1655mm

## FlexiGrid Configuration 5.

9x wide multi-tiered shelving with fabric infill panels, 2x double width cubbies, 2x single width cubbies. Wall bracket included.

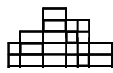
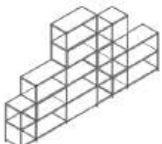

FINISH

WIDTH

DEPTH

HEIGHT

FlexiGrid05

White/Black/Oak/ Fabric

3620mm

420mm

2055mm

## FlexiGrid Configuration 6.

4x wide shelving & cupboard with TV cubby. Wall bracket included.

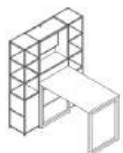

FINISH

WIDTH

DEPTH

HEIGHT

FlexiGrid06

White/ Oak/ Black



1620mm

420mm

2055mm



**FlexiGrid Configuration 7.**

6x wide shelving & cupboard with central TV gap. Wall bracket included.

				
	FINISH	WIDTH	DEPTH	HEIGHT
FlexiGrid07	White/Black/ Acrylic	2420mm	420mm	2055mm

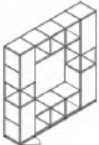

**FlexiGrid Configuration 8.**

5x wide shelving with cupboards and central TV gap. Wall bracket included.

				
	FINISH	WIDTH	DEPTH	HEIGHT
FlexiGrid08	White/ Oak/Black	2020mm	420mm	2055mm

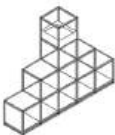

**FlexiGrid Configuration 9.**

5x wide multi-tiered shelving with 6x single cubbies & 1x single planter. Wall bracket included.

				
	FINISH	WIDTH	DEPTH	HEIGHT
FlexiGrid09	White/Black/Oak	2020mm	420mm	1655mm



**FlexiGrid Configuration 10.**

3x wide shelving & cupboard. Wall bracket included.

				
	FINISH	WIDTH	DEPTH	HEIGHT
FlexiGrid10	Oak/Black	1220mm	420mm	2055mm



**FlexiGrid Configuration 11.**

5x wide single tiered shelving with 5x cubbies. Black, white & oak finish. Wall bracket included.

				
	FINISH	WIDTH	DEPTH	HEIGHT
FlexiGrid11	White/Black/Oak	2020mm	420mm	801mm

**FlexiGrid Configuration 12.**

4x wide shelving with 2x single planters & 4x single cubbies. White & black finish. Wall bracket included.

				
	FINISH	WIDTH	DEPTH	HEIGHT
FlexiGrid12	White/Black	1620mm	420mm	1655mm





office chairs





cote

## HOW TO SPECIFY COTE

C	O	T	E
---	---	---	---

CODE  
(E.G: 'COTE')

*	*
---	---

TYPE  
(E.G: '06')

*	*	*
---	---	---

MOBILE  
(E.G: 'MOB')

*	*	*	*	*
---	---	---	---	---

INNER FABRIC COLOUR  
(EG: 'SUR21')

*	*	*	*	*
---	---	---	---	---

OUTER FABRIC COLOUR  
(EG: 'SUR23')

For example, to specify a low back armchair with two tone fabric in Camira Sumi Mito SUR21 Inner fabric and Sumi Tono SUR23 , the code will be COTE06SUR21SUR23. Shown with additional matching bolster cushions COTEBOLSTERSUR21.

### Frame Colours

Black

### Band 1 MFC Finishes

White	WHM
White/ Oak Edge	WHO
White/ Black Edge	WHB
Pale Grey	MOG
Dust Grey	DGM
Light Oak*	MOK*
Walnut*	MOW*

*\*Please note, we cannot guarantee continuity of these finishes.*

### Band 2 MFC Finishes

Cashmere Grey	MSC
Antique Rose	MAR
Reed Green	MRG
Denim Blue	MDB
Hamilton Oak	MHO
Nebraska Oak	MNO
Truffle Brown Oak	MDO
Natural Carini Walnut	MCW
Sevilla Ash	MSA
Chicago Concrete	MCC

### Fabric Band B

Camira Era  
Camira Rivet

### Fabric Band C

Camira Advantage  
Camira Aspect  
Camira Xtreme  
Camira Manhattan  
Camira Urban  
Camira Chateau  
Camira Main Line Plus  
Camira X2  
Camira Quest

### Fabric Band D

Camira 24/7 Flax  
Camira Aquarius  
Camira Blazer  
Camira Main Line Flax  
Camira Silk  
Camira Synergy  
Camira Synergy 170  
Camira Track  
Camira Sumi  
Camira Oceanic  
Camira Main Line Twist  
Camira Vita

# cote

## /low back armchair & sofa

### Cote Low Back Armchair

38mm static round foot or lockable castors. Seat height: 480mm.

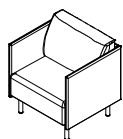

LEG/ CASTOR	WIDTH	DEPTH	HEIGHT
-------------	-------	-------	--------

COTE06 *****	Static Leg	790mm	760mm	790mm
COTE06MOB *****	Lockable Castor	790mm	760mm	790mm

### Cote Low Back 2 Seater Sofa

38mm static round foot or lockable castors. Seat height: 480mm.

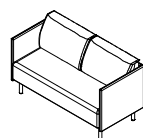

LEG/ CASTOR	WIDTH	DEPTH	HEIGHT
-------------	-------	-------	--------

COTE05 *****	Static Leg	1520mm	760mm	790mm
COTE05MOB *****	Lockable Castor	1520mm	760mm	790mm

# /high back armchair & sofa

### Cote High Back Armchair

38mm static round foot or lockable castors. Seat height: 480mm.

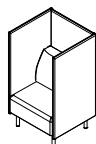

LEG/ CASTOR	WIDTH	DEPTH	HEIGHT
-------------	-------	-------	--------

COTE02 *****	Static Leg	790mm	760mm	1400mm
COTE02MOB *****	Lockable Castor	790mm	760mm	1400mm

### Cote High Back 2 Seater Sofa

38mm static round foot. Seat height: 480mm.

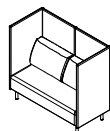

LEG/ CASTOR	WIDTH	DEPTH	HEIGHT
-------------	-------	-------	--------

COTE03 *****	Static Leg	1520mm	760mm	1400mm
COTE03MOB *****	Lockable Castor	1520mm	760mm	1400mm

# /high back meeting booths

## Cote High Back 1-2-1 Meeting Booth

38mm static round foot. Seat height: 480mm. Table features scalloped edge to clamp a power module onto.

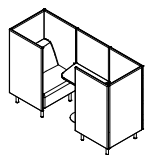

TOP

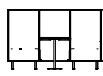

WIDTH



DEPTH

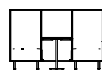

HEIGHT

COTE04 ***** **	Band 1 MFC	2190mm	790mm	1400mm
COTE04 ***** **	Band 2 MFC	2190mm	790mm	1400mm

## Cote High Back 4 Person Meeting Booth

38mm static round foot. Seat height: 480mm. Table features scalloped edge to clamp a power module onto.

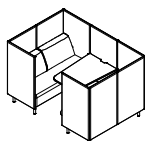

TOP

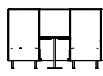

WIDTH



DEPTH

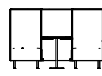

HEIGHT

COTE01 ***** **	Band 1 MFC	2190mm	1520mm	1400mm
COTE01 ***** **	Band 2 MFC	2190mm	1520mm	1400mm

# /accessories

### Monitor Bracket for 32" TVs. Suitable for 4 Person Meeting Booth Only.

TV not included.

COTETVMOUNT.

### Bracket to mount OE Phase Power Module under the chair seat. Suitable for all units.

OE Phase power unit not included.

COTEPOWERBKT.

### Cable Sock for Cable Management. Suitable for Meeting Booths

Fabric to match booth fabric.

COTESOCK \*\*\*\*\*.

### Bolster Cushions (Pair).

Media Booths requires 1 extra set. (4 cushions in total)

Fabric Band B. COTEBOLSTER \*\*\*\*.

Fabric Band C. COTEBOLSTER \*\*\*\*.

Fabric Band D. COTEBOLSTER \*\*\*\*.







# equity chair

## HOW TO SPECIFY EQUITY



**TOP CODE** (E.G: 'ET')   
 **BACK** (E.G: 'M')   
 **MECH.** (E.G: 'B')   
 **SEAT SLIDE** (E.G: 'SS')   
 **ARMS** (E.G: '2D')   
 **BASE** (E.G: 'A')   
 **FRAME** (E.G: 'B')   
**BACK FABRIC** (For example: 01101')   
**SEAT FABRIC** (For example: 'JA201')

For example, to specify an Equity task chair with no arms, black frame, Gabriel Web black 01101 mesh back, and an upholstered seat in Camira Aquarius Courgette JA201 the code would be ETMBNAB01101JA201.

### Mechanisms

Body Balance                    B  
 Body Balance and Seat Slide    BSS

### Back

Mesh                                M  
 Upholstered                        U

### Arms

No Arms                            NA  
 2D Arms (up/down)            2D  
 4D Arms (up/down, slide forward and rotate out)    4D

### Base

Black (Standard)                -  
 Aluminium                        A

### Frame Finish

Black                                B  
 White                                W  
*Please note white frame chairs have black arms (if applicable) and a black base*

### Mesh Colours

Gabriel Web Black 01101  
 Gabriel Web Mid Grey 03101  
 Gabriel Web Dark Grey 02101

### Fabric Colours





Fabric Band 1-5 & Leather  
 Colour code as per fabric manufacturers code. See the back of the brochure for full fabric band guide.

# equity task chair /mesh back

Equity Mesh Back Task Chair with body balance mechanism. Without or with Headrest 'HR'.

Hard castors as standard. Adjustable lumbar support with 100mm of adjustment.





No arms (NA), 2D arms (2D) or 4D arms (4D). Black or white frame.

	ARMS	HEAD REST	 WIDTH	 DEPTH	 HEIGHT	 SEAT HEIGHT
ETMBNA * *****	NA	N/a	605mm	590mm	1080mm	480-570
ETMB2D * *****	2D	N/a	660mm	590mm	1080mm	480-570
ETMB4D * *****	4D	N/a	660mm	590mm	1080mm	480-570
ETMBNA * ***** HR	NA	H/Rest	605mm	590mm	1260mm	480-570
ETMB2D * ***** HR	2D	H/Rest	660mm	590mm	1260mm	480-570
ETMB4D * ***** HR	4D	H/Rest	660mm	590mm	1260mm	480-570

Equity Mesh Back Task Chair with body balance mechanism and **seat slide**. Without or with Headrest 'HR'.

Mesh back and upholstered seat pad. Hard castors as standard. Adjustable lumbar support with 100mm of adjustment.





No arms (NA), 2D arms (2D) or 4D arms (4D). Black or white frame.

	ARMS	HEAD REST	 WIDTH	 DEPTH	 HEIGHT	 SEAT HEIGHT
ETMBSSNA * *****	NA	N/a	605mm	590mm	1080mm	480-570
ETMBSS2D * *****	2D	N/a	660mm	590mm	1080mm	480-570
ETMBSS4D * *****	4D	N/a	660mm	590mm	1080mm	480-570
ETMBSSNA * ***** HR	NA	H/Rest	605mm	590mm	1260mm	480-570
ETMBSS2D * ***** HR	2D	H/Rest	660mm	590mm	1260mm	480-570
ETMBSS4D * ***** HR	4D	H/Rest	660mm	590mm	1260mm	480-570





Equity Mesh Back Task Chair with body balance mechanism. Without or with Headrest 'HR'.

Hard castors as standard. Adjustable lumbar support with 100mm of adjustment. **Aluminium base.**

No arms (NA), 2D arms (2D) or 4D arms (4D). Black or white frame.





	ARMS	HEAD REST	 WIDTH	 DEPTH	 HEIGHT	 SEAT HEIGHT
ETMBNAA * *****	NA	N/a	605mm	590mm	1080mm	480-570
ETMB2DA * *****	2D	N/a	660mm	590mm	1080mm	480-570
ETMB4DA * *****	4D	N/a	660mm	590mm	1080mm	480-570
ETMBNAA * ***** HR	NA	H/Rest	605mm	590mm	1260mm	480-570
ETMB2DA * ***** HR	2D	H/Rest	660mm	590mm	1260mm	480-570
ETMB4DA * ***** HR	4D	H/Rest	660mm	590mm	1260mm	480-570

**Equity Mesh Back Task Chair with body balance mechanism and seat slide. Without or with Headrest 'HR'.**  
**Hard castors as standard. Adjustable lumbar support with 100mm of adjustment. Aluminium Base.**  
 No arms (NA), 2D arms (2D) or 4D arms (4D). Black or white frame.





	ARMS	HEAD REST	 WIDTH	 DEPTH	 HEIGHT	 SEAT HEIGHT
ETMBSSNAA * *****	NA	N/a	605mm	590mm	1080mm	480-570
ETMBSS2DA * *****	2D	N/a	660mm	590mm	1080mm	480-570
ETMBSS4DA * *****	4D	N/a	660mm	590mm	1080mm	480-570
ETMBSSNAA * ***** HR	NA	H/Rest	605mm	590mm	1260mm	480-570
ETMBSS2DA * ***** HR	2D	H/Rest	660mm	590mm	1260mm	480-570
ETMBSS4DA * ***** HR	4D	H/Rest	660mm	590mm	1260mm	480-570

## /upholstered back





**Equity Upholstered Back Task Chair with body balance mechanism. Without or with Headrest 'HR'.**  
**Hard castors as standard. Adjustable lumbar support with 100mm of adjustment.**  
 No arms (NA), 2D arms (2D) or 4D arms (4D). Black or white frame.

	ARMS	HEAD REST	 WIDTH	 DEPTH	 HEIGHT	 SEAT HEIGHT
ETUBNA * *****	NA	N/a	605mm	590mm	1080mm	480-570
ETUB2D * *****	2D	N/a	660mm	590mm	1080mm	480-570
ETUB4D * *****	4D	N/a	660mm	590mm	1080mm	480-570
ETUBNA * ***** HR	NA	H/Rest	605mm	590mm	1260mm	480-570
ETUB2D * ***** HR	2D	H/Rest	660mm	590mm	1260mm	480-570
ETUB4D * ***** HR	4D	H/Rest	660mm	590mm	1260mm	480-570





**Equity Upholstered Back Task Chair with body balance mechanism and seat slide. Without or with Headrest 'HR'.**  
**Hard castors as standard. Adjustable lumbar support with 100mm of adjustment.**  
 No arms (NA), 2D arms (2D) or 4D arms (4D). Black or white frame.

	ARMS	HEAD REST	 WIDTH	 DEPTH	 HEIGHT	 SEAT HEIGHT
ETUBSSNA * *****	NA	N/a	605mm	590mm	1080mm	480-570
ETUBSS2D * *****	2D	N/a	660mm	590mm	1080mm	480-570
ETUBSS4D * *****	4D	N/a	660mm	590mm	1080mm	480-570
ETUBSSNA * *****HR	NA	H/Rest	605mm	590mm	1260mm	480-570
ETUBSS2D * *****HR	2D	H/Rest	660mm	590mm	1260mm	480-570
ETUBSS4D * *****HR	4D	H/Rest	660mm	590mm	1260mm	480-570

Equity Upholstered Back Task Chair with body balance mechanism. Without or with Headrest 'HR'.  
 Hard castors as standard. Adjustable lumbar support with 100mm of adjustment. **Aluminium base.**  
 No arms (NA), 2D arms (2D) or 4D arms (4D). Black or white frame.

	ARMS	HEAD REST				
			WIDTH	DEPTH	HEIGHT	SEAT HEIGHT
ETUBNAA * *****	NA	N/a	605mm	590mm	1080mm	480-570
ETUB2DA * *****	2D	N/a	660mm	590mm	1080mm	480-570
ETUB4DA * *****	4D	N/a	660mm	590mm	1080mm	480-570
ETUBNAA * ***** HR	NA	H/Rest	605mm	590mm	1260mm	480-570
ETUB2DA * ***** HR	2D	H/Rest	660mm	590mm	1260mm	480-570
ETUB4DA * ***** HR	4D	H/Rest	660mm	590mm	1260mm	480-570

Equity Upholstered Back Task Chair with body balance mechanism and **seat slide**. Without or with Headrest 'HR'.  
 Hard castors as standard. Adjustable lumbar support with 100mm of adjustment. **Aluminium Base.**  
 No arms (NA), 2D arms (2D) or 4D arms (4D). Black or white frame.

	ARMS	HEAD REST				
			WIDTH	DEPTH	HEIGHT	SEAT HEIGHT
ETUBSSNAA * *****	NA	N/a	605mm	590mm	1080mm	480-570
ETUBSS2DA * *****	2D	N/a	660mm	590mm	1080mm	480-570
ETUBSS4DA * *****	4D	N/a	660mm	590mm	1080mm	480-570
ETUBSSNAA * ***** HR	NA	H/Rest	605mm	590mm	1260mm	480-570
ETUBSS2DA * ***** HR	2D	H/Rest	660mm	590mm	1260mm	480-570
ETUBSS4DA * ***** HR	4D	H/Rest	660mm	590mm	1260mm	480-570

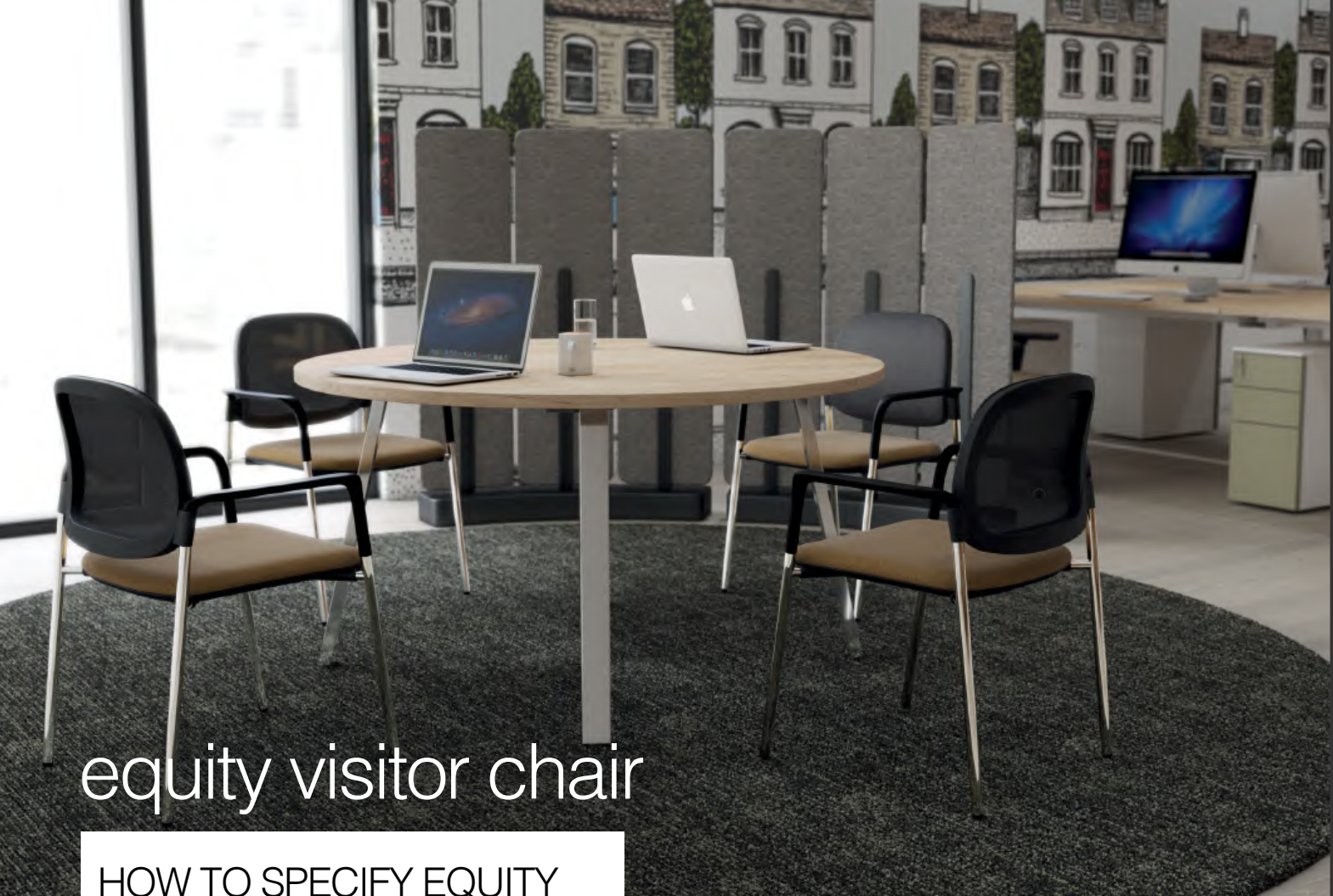

# equity visitor chair

## HOW TO SPECIFY EQUITY



TOP CODE  
(E.G: 'EV')

ARM CODE  
(E.G: '-A')

BACK CODE  
(E.G: 'MB')

BASE  
(E.G: '4L')

BASE FINISH  
(E.G: 'B')

BACK FABRIC  
(E.G: 'YS009')

SEAT FABRIC  
(E.G: 'YS009')

For example, to specify an Equity visitor chair with 4 chrome legs, arms and a fully upholstered back and seat in Camira Xtreme Havana YS009 fabric the code would be EV-AUB4LCYS009YS009.

### Mesh Colours

- Gabriel Web Black 01101
- Gabriel Web Mid Grey 03101
- Gabriel Web Dark Grey 02101

### Arms/ Tablet

- Loop Arms -A
  - Right Hand Tablet -RT
- For no arms, leave '-A' out of the code.*

### Leg Finish

- Black B
- Chrome C

### Fabric Colours

- Fabric Band 1-5 & Leather. Colour code as per fabric manufacturers code. See the back of the brochure for full fabric band guide.

For Left hand tablets, a minimum order quantity applies. Please contact Flexiform for information.

# equity visitor chair

## Equity visitor chair with 4 legs and perforated plastic back.

No arms, arms (-A), or tablet (-RT). Black or chrome frame. Back colour is always black, \*\*\*\*\* to specify seat pad.



	LEGS	ARMS	WIDTH	DEPTH	HEIGHT	SEAT HEIGHT
EVPB4LB *****	Black	N/a	545mm	570mm	830mm	500mm
EVPB4LC *****	Chrome	N/a	545mm	570mm	830mm	500mm
EV-APB4LB *****	Black	Arms	595mm	570mm	830mm	500mm
EV-APB4LC *****	Chrome	Arms	595mm	570mm	830mm	500mm
EV-RTPB4LB *****	Black	Tablet	800mm	570mm	830mm	500mm
EV-RTPB4LC *****	Chrome	Tablet	800mm	570mm	830mm	500mm

## Equity visitor chair with 4 legs and mesh back.

No arms, arms (-A), or tablet (-RT). Black or chrome frame.



	LEGS	ARMS	WIDTH	DEPTH	HEIGHT	SEAT HEIGHT
EVMB4LB *****	Black	N/a	545mm	570mm	830mm	500mm
EVMB4LC *****	Chrome	N/a	545mm	570mm	830mm	500mm
EV-AMB4LB *****	Black	Arms	595mm	570mm	830mm	500mm
EV-AMB4LC *****	Chrome	Arms	595mm	570mm	830mm	500mm
EV-RTMB4LB *****	Black	Tablet	800mm	570mm	830mm	500mm
EV-RTMB4LC *****	Chrome	Tablet	800mm	570mm	830mm	500mm

## Equity visitor chair with 4 legs and upholstered back.

No arms, arms (-A), or tablet (-RT). Black or chrome frame.



	LEGS	ARMS	WIDTH	DEPTH	HEIGHT	SEAT HEIGHT
EVUB4LB *****	Black	N/a	545mm	570mm	830mm	500mm
EVUB4LC *****	Chrome	N/a	545mm	570mm	830mm	500mm
EV-AUB4LB *****	Black	Arms	595mm	570mm	830mm	500mm
EV-AUB4LC *****	Chrome	Arms	595mm	570mm	830mm	500mm
EV-RTUB4LB *****	Black	Tablet	800mm	570mm	830mm	500mm
EV-RTUB4LC *****	Chrome	Tablet	800mm	570mm	830mm	500mm

## Equity visitor chair with chrome cantilever frame and perforated plastic back.





No arms, or arms (-A). Chrome frame. Back colour is always black, \*\*\*\*\* to specify seat pad.



	LEGS	ARMS	WIDTH	DEPTH	HEIGHT	SEAT HEIGHT
EVPBCAC *****	Chrome	N/a	545mm	570mm	830mm	500mm
EV-APBCAC *****	Chrome	Arms	595mm	570mm	830mm	500mm
EV-RTPBCAC *****	Chrome	Tablet	800mm	570mm	830mm	500mm





**Equity visitor chair with chrome cantilever frame and mesh back.**

No arms, arms (-A) or tablet (-RT). Chrome frame.

		LEGS		ARMS	WIDTH		DEPTH		HEIGHT		SEAT HEIGHT
EVNBCAC *****	Chrome	N/a	545mm	570mm	830mm	500mm					
EV-AMBCAC *****	Chrome	Arms	595mm	570mm	830mm	500mm					
EV-RTMBCAC *****	Chrome	Tablet	800mm	570mm	830mm	500mm					

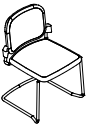
**Equity visitor chair with chrome cantilever frame and upholstered back.**

No arms, arms (-A) or tablet (-RT). Chrome frame.

		LEGS		ARMS	WIDTH		DEPTH		HEIGHT		SEAT HEIGHT
EVUBCAC *****	Chrome	N/a	545mm	570mm	830mm	500mm					
EV-AUBCAC *****	Chrome	Arms	595mm	570mm	830mm	500mm					
EV-RTUBCAC *****	Chrome	Tablet	800mm	570mm	830mm	500mm					







# actualize chair

## HOW TO SPECIFY ACTUALIZE



TOP CODE (E.G: 'AT')   
 BACK (E.G: 'M')   
 MECH. (E.G: 'B')   
 SEAT SLIDE (E.G: 'SS')   
 ARMS (E.G: '2D')   
 BASE (E.G: 'A')   
 FRAME (E.G: 'B')   
 BACK FABRIC (E.G: '01101')   
 SEAT FABRIC (E.G: 'EJ186')





For example, to specify an Actualize Mesh Back Task Chair with synchronous mechanism, seat slide, 2D arms, black base and arms, Gabriel Web black 01101 mesh back and Camira Cara Fair Isle EJ186 seat pad, the code would be ATMBSS2DB01101EJ186.

<b>Back</b>		<b>Arms</b>		<b>Frame Finish</b>		<b>Fabric Colours</b>
Mesh	M	No Arms	NA	Black	B	Fabric Band 1-5 & Leather.
Upholstered	U	2D Arms (up/down)	2D	White	W	Colour code as per fabric manufacturers code. See the back of the brochure for full fabric band guide.
		4D Arms (up/down, slide forward and rotate out)	4D			
		<b>Base</b>		<b>Mesh Colours</b>		
		Black (Standard)	-	Gabriel Web Black 01101		
		Aluminium	A	Gabriel Web Mid Grey 03101		
				Gabriel Web Dark Grey 02101		
		<b>Headrest</b>				
		Upholstered Headrest with height adjustable and rotating mechanism	UH			





# actualize

## /mesh back

Actualize Mesh Back Task Chair with synchronous mechanism and 50mm seat slide. Mesh back and upholstered seat pad. Hard castors as standard. Adjustable lumbar support with 100mm of adjustment. No arms (NA), 2D arms (2D) or 4D arms (4D). Black frame, base and arms.





						
	ARMS	WIDTH	DEPTH	HEIGHT	SEAT HEIGHT	
ATMBSSNA B *****	NA	720mm	565mm	1030/1155	465/590	
ATMBSS2D B *****	2D	720mm	565mm	1030/1155	465/590	
ATMBSS4D B *****	4D	720mm	565mm	1030/1155	465/590	
ATMBSSNA B ***** UH	NA	720mm	600mm	1230/1355	465/590	
ATMBSS2D B ***** UH	2D	720mm	600mm	1230/1355	465/590	
ATMBSS4D B ***** UH	4D	720mm	600mm	1230/1355	465/590	

Actualize Mesh Back Task Chair with synchronous mechanism and 50mm seat slide. Mesh back and upholstered seat pad. Hard castors as standard. Adjustable lumbar support with 100mm of adjustment. **Aluminium Base.** Black (B) or white (W) frame (priced individually), aluminium base, 4D arms.

						
	ARMS	WIDTH	DEPTH	HEIGHT	SEAT HEIGHT	
ATMBSS4DAB *****	4D	720mm	565mm	1030/1155	465/590	
ATMBSS4DAW *****	4D	720mm	565mm	1030/1155	465/590	
ATMBSS4DAB *****UH	4D	720mm	600mm	1230/1355	465/590	
ATMBSS4DAW *****UH	4D	720mm	600mm	1230/1355	465/590	

## /upholstered back

Actualize Upholstered Back Task Chair with synchronous mechanism and 50mm seat slide. Upholstered back and seat pad. Hard castors as standard. No arms (NA), 2D arms (2D) or 4D arms (4D). Black frame, base and arms.

						
	ARMS	WIDTH	DEPTH	HEIGHT	SEAT HEIGHT	
ATUBSSNA B *****	NA	720mm	545mm	1030/1155	465/590	
ATUBSS2D B *****	2D	720mm	545mm	1030/1155	465/590	
ATUBSS4D B *****	4D	720mm	545mm	1030/1155	465/590	
ATUBSSNA B ***** UH	NA	720mm	615mm	1230/1360	465/590	
ATUBSS2D B ***** UH	2D	720mm	615mm	1230/1360	465/590	
ATUBSS4D B ***** UH	4D	720mm	615mm	1230/1360	465/590	

Actualize Upholstered Back Task Chair with synchronous mechanism and 50mm seat slide.

Upholstered back and seat pad. Hard castors as standard. **Aluminium Base.**

Black (B) or white (W) frame (priced individually), aluminium base, 4D arms.



	ARMS	WIDTH	DEPTH	HEIGHT	SEAT HEIGHT
--	------	-------	-------	--------	-------------

ATUBSS4DAB *****	4D	720mm	545mm	1030/1155	465/590
ATUBSS4DAW *****	4D	720mm	545mm	1030/1155	465/590
ATUBSS4DAB *****UH	4D	720mm	615mm	1230/1360	465/590
ATUBSS4DAW *****UH	4D	720mm	615mm	1230/1360	465/590





# miss chairs

## HOW TO SPECIFY MISS CHAIRS

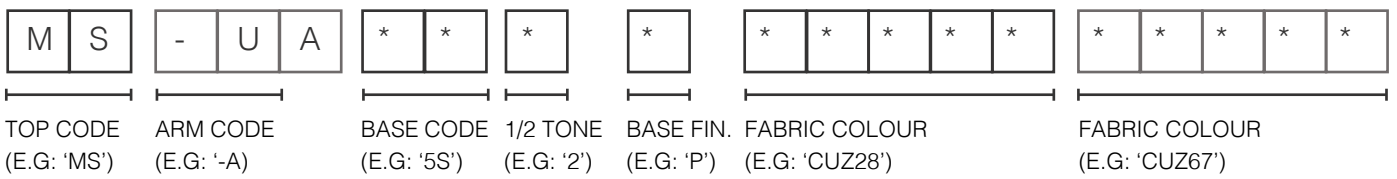

For example, to specify a Miss chair with a 5 star polished base and loop chrome rod arms, in two tone option 2 (inside/outside). Inside: Camira Blazer Silverdale CUZ28, Outside: Camira Blazer Kingsmead CUZ67 the code would be MS-A5S2PCUZ28CUZ67.

### One or Two Tone Fabric

One Fabric	0
Two Tone Option 1 (Back/ Seat)	1
Two Tone Option 2 (Inside/Outside)	2

### Arms

Chrome loop arms	-A
Upholstered arms	-UA
<i>For no arms, leave '-A' or '-UA' out of the code.</i>	

*Upholstered arms always match the seat fabric regardless of two tone fabric options*

### Base Finish

Chrome (Skid Only)	C
Black (Skid Only)	B
Polished (4 Star/ 5 Star)	P
<b>Wooden Frames Only</b>	
Oak Staining	O
Available on extended lead times	
Walnut Staining	N
Black Staining	B
White Staining	W

### Fabric Colours

Fabric Band 1-5 & Leather. Colour code as per fabric manufacturers code. See the back of the brochure for full fabric band guide.

# miss chair

## Miss chair with skid frame.

No arms, or rod arms (-A), available in single, two tone 1 (back/seat) and two tone 2 (inside/outside). Chrome (C) or Black (B) frame.

	FABRIC	ARMS	WIDTH	DEPTH	HEIGHT	SEAT HEIGHT
MSSK0C*****	Single	N/a	470mm	540mm	850mm	460mm
MSSK*C*****	Two Tone	N/a	470mm	540mm	850mm	460mm
MS-ASK0C*****	Single	Arms	520mm	540mm	850mm	460mm
MS-ASK*C*****	Two Tone	Arms	520mm	540mm	850mm	460mm

## Miss chair with wooden 4 leg frame.

No arms, or chrome rod arms (-A), available in single, two tone 1 (back/seat) and two tone 2 (inside/outside).

	FABRIC	ARMS	WIDTH	DEPTH	HEIGHT	SEAT HEIGHT
MS4W0* *****	Single	N/a	490mm	540mm	840mm	450mm
MS4W* * *****	Two Tone	N/a	490mm	540mm	840mm	450mm
MS-A4W0* *****	Single	Arms	520mm	540mm	840mm	450mm
MS-A4W* * *****	Two Tone	Arms	520mm	540mm	840mm	450mm

## Miss chair with polished aluminium flat 4 star base with gas lift.

No arms, or chrome rod arms (-A), available in single, two tone 1 (back/seat) and two tone 2 (inside/outside).

	FABRIC	ARMS	WIDTH	DEPTH	HEIGHT	SEAT HEIGHT
MS4S0P*****	Single	N/a	470mm	540mm	735-860	365-490
MS4S*P*****	Two Tone	N/a	470mm	540mm	735-860	365-490
MS-A4S0P*****	Single	Arms	520mm	540mm	735-860	365-490
MS-A4S*P*****	Two Tone	Arms	520mm	540mm	735-860	365-490

## Miss chair with 5 star polished aluminium swivel base, gas lift and castors. Optional tilt mechanism (T).

No arms, or chrome rod arms (-A), available in single, two tone 1 (back/seat) and two tone 2 (inside/outside).

	FABRIC	ARMS	WIDTH	DEPTH	HEIGHT	SEAT HEIGHT
MS5S0P*****	Single	N/a	697mm	663mm	810-910	420-520
MS5ST0P*****	Single	N/a	697mm	663mm	810-910	420-520
MS5S*P*****	Two Tone	N/a	697mm	663mm	810-910	420-520
MS5ST*P*****	Two Tone	N/a	697mm	663mm	810-910	420-520
MS-A5S0P*****	Single	Arms	697mm	663mm	810-910	420-520
MS-A5ST0P*****	Single	Arms	697mm	663mm	810-910	420-520
MS-A5S*P*****	Two Tone	Arms	697mm	663mm	810-910	420-520
MS-A5ST*P*****	Two Tone	Arms	697mm	663mm	810-910	420-520

# miss collaborative

## Miss chair with chrome rod skid frame.

No arms, or upholstered arms (-UA), available in single, two tone 1 (back/seat) and two tone 2 (inside/outside).  
Chrome (C) or black (B) base.

	FABRIC	ARMS	WIDTH	DEPTH	HEIGHT	SEAT HEIGHT
MSCSK0C*****	Single	N/a	530mm	540mm	850mm	460mm
MSCSK*C*****	Two Tone	N/a	530mm	540mm	850mm	460mm
MSC-UASK0C*****	Single	Arms	650mm	540mm	850mm	460mm
MSC-UASK*C*****	Two Tone	Arms	650mm	540mm	850mm	460mm

## Miss chair with wooden 4 leg frame.

No arms, or upholstered arms (-UA), available in single, two tone 1 (back/seat) and two tone 2 (inside/outside).

	FABRIC	ARMS	WIDTH	DEPTH	HEIGHT	SEAT HEIGHT
MSC4W0* ****	Single	N/a	530mm	540mm	840mm	450mm
MSC4W* * *****	Two Tone	N/a	530mm	540mm	840mm	450mm
MSC-UA4W0* ****	Single	Arms	650mm	540mm	840mm	450mm
MSC-UA4W* * *****	Two Tone	Arms	650mm	540mm	840mm	450mm

## Miss chair with polished aluminium flat 4 star base with gas lift.

No arms, or upholstered arms (-UA), available in single, two tone 1 (back/seat) and two tone 2 (inside/outside).

	FABRIC	ARMS	WIDTH	DEPTH	HEIGHT	SEAT HEIGHT
MSC4S0P*****	Single	N/a	530mm	540mm	735-860	365-490
MSC4S*P*****	Two Tone	N/a	530mm	540mm	735-860	365-490
MSC-UA4S0P*****	Single	Arms	650mm	540mm	735-860	365-490
MSC-UA4S*P*****	Two Tone	Arms	650mm	540mm	735-860	365-490

## Miss chair with 5 star polished aluminium swivel base, gas lift and castors. Optional tilt mechanism (T).

No arms, or upholstered arms (-UA), available in single, two tone 1 (back/seat) and two tone 2 (inside/outside).

	FABRIC	ARMS	WIDTH	DEPTH	HEIGHT	SEAT HEIGHT
MSC5S0P*****	Single	N/a	697mm	663mm	810-910	420-520
MSC5ST0P*****	Single	N/a	697mm	663mm	810-910	420-520
MSC5S*P*****	Two Tone	N/a	697mm	663mm	810-910	420-520
MSC5ST*P*****	Two Tone	N/a	697mm	663mm	810-910	420-520
MSC-UA5S0P*****	Single	Arms	697mm	663mm	810-910	420-520
MSC-UA5ST0P*****	Single	Arms	697mm	663mm	810-910	420-520
MSC-UA5S*P*****	Two Tone	Arms	697mm	663mm	810-910	420-520
MSC-UA5ST*P*****	Two Tone	Arms	697mm	663mm	810-910	420-520



# miss stool

Miss stool with wooden frame and integral chrome rod footrail. Three-quarter fully upholstered back.

No arms, available in single, two tone 1 (back/seat) and two tone 2 (inside/outside).



	FABRIC	WIDTH	DEPTH	HEIGHT	SEAT HEIGHT
MSSTW0 * *****	Single	460mm	480mm	930mm	780mm
MSSTW* * ***** *****	Two Tone	460mm	480mm	930mm	780mm

Miss stool with wire frame and integral chrome rod footrail. Three-quarter fully upholstered back.

No arms, available in single, two tone 1 (back/seat) and two tone 2 (inside/outside). Chrome (C) or Black (B) base.



	FABRIC	WIDTH	DEPTH	HEIGHT	SEAT HEIGHT
MSSTM0 * *****	Single	460mm	480mm	930mm	780mm
MSSTM* * ***** *****	Two Tone	460mm	480mm	930mm	780mm



# small valido lounge chair

## HOW TO SPECIFY VALIDO CHAIRS



**TOP CODE** (E.G: VA')   
 **BASE CODE** (E.G: '4W')   
 **1/2 TONE** (E.G: '0')   
 **BASE FINISH** (E.G: 'O')   
 **FABRIC COLOUR** (E.G: 'REG08')   
 **FABRIC COLOUR** (E.G: 'REG08')

For example, to specify a Valido chair with an oak stained 4 leg wooden frame fully upholstered in Camira Regent Minack REG08 the code would be VA4W00REG08.

### One or Two Tone Fabric

One Fabric	0
Two Tone Option 1 (Back/ Seat)	1
Two Tone Option 2 (Inside/Outside)	2

### Base Finish

Chrome (Skid Only)	C
Polished (4 Star/ 5 Star & Raised Base)	P

### Wooden Frames Only

Oak Staining	O
--------------	---

Available on extended lead times

Walnut Staining	N
Black Staining	B
White Staining	W

### Fabric Colours

Fabric Band 1-5 & Leather. Colour code as per fabric manufacturers code. See the back of the brochure for full fabric band guide.

# small valido lounge chair

Valido small lounge chair with chrome rod skid frame.

No arms. Chrome frame.

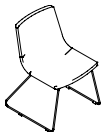

	FABRIC	WIDTH	DEPTH	HEIGHT	SEAT HEIGHT
VASK0 * *****	Single	565mm	570mm	800mm	455mm
VASK* * ***** *****	Two Tone	565mm	570mm	800mm	455mm

Valido small lounge chair with polished aluminium raised 4 star base and swivel mechanism.

No arms.



	FABRIC	WIDTH	DEPTH	HEIGHT	SEAT HEIGHT
VAKY0P*****	Single	510mm	590mm	800mm	455mm
VAKY*P***** *****	Two Tone	510mm	590mm	800mm	455mm

Valido small lounge chair with raised 4 leg wood base.

No arms.



	FABRIC	WIDTH	DEPTH	HEIGHT	SEAT HEIGHT
VARW0 * *****	Single	490mm	545mm	800mm	455mm
VARW* * ***** *****	Two Tone	490mm	545mm	800mm	455mm

Valido small lounge chair with polished flat 4 star aluminium base and swivel mechanism.

No arms

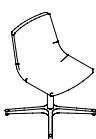

	FABRIC	WIDTH	DEPTH	HEIGHT	SEAT HEIGHT
VA4S0P*****	Single	535mm	535mm	800mm	455mm
VA4S*P***** *****	Two Tone	535mm	535mm	800mm	455mm

Valido small lounge chair with wooden 4 leg frame.

No arms.



	FABRIC	WIDTH	DEPTH	HEIGHT	SEAT HEIGHT
VA4W0 * *****	Single	510mm	590mm	800mm	455mm
VA4W* * ***** *****	Two Tone	510mm	590mm	800mm	455mm



# valido lounge chair

## HOW TO SPECIFY VALIDO LOUNGE CHAIR



TOP CODE  
(E.G: 'LVA')

BASE CODE  
(E.G: '4W')

1/2 TONE  
(E.G: '0')

HEADREST  
(E.G: 'HR')

BASE  
(E.G: 'O')

FABRIC COLOUR  
(E.G: 'REG14')

FABRIC COLOUR  
(E.G: 'REG14')

For example, to specify a Valido chair with an oak stained raised 4 leg wooden frame in Camira Regent Opera REG14 the code would be LVA4WOREG14.

### One or Two Tone Fabric

One Fabric	0
Two Tone Option 1 (Back/ Seat)	1
Two Tone Option 2 (Inside/Outside)	2

### Base Finish

Chrome (Skid Only)	C
Polished (4 Star/ 5 Star & Raised Base)	P
<b>Wooden Frames Only</b>	
Beech	O

### Fabric Colours

Fabric Band 1-5 & Leather  
Colour code as per fabric  
manufacturers code. See the  
back of the brochure for full  
fabric band guide.





Available on extended lead times

Walnut Staining	N
Black Staining	B
White Staining	W

# large valido lounge chair

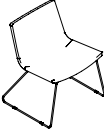



Valido lounge chair with chrome rod skid frame. With & Without Headrest (HR).

No arms. Chrome frame.

					
	FABRIC	WIDTH	DEPTH	HEIGHT	SEAT HEIGHT
LVASKO * *****	Single	650mm	590mm	755mm	470mm
LVASK* * ***** *****	Two Tone	650mm	590mm	755mm	470mm
LVASK0HR * *****	Single	650mm	650mm	970mm	470mm
LVASK*HR * ***** *****	Two Tone	650mm	650mm	970mm	470mm



Valido lounge chair with polished aluminium flat 4 star base and swivel mechanism. With & Without Headrest (HR).

No arms.

					
	FABRIC	WIDTH	DEPTH	HEIGHT	SEAT HEIGHT
LVA4S0P*****	Single	575mm	590mm	755mm	470mm
LVA4S*P***** *****	Two Tone	575mm	590mm	755mm	470mm
LVA4S0HRP*****	Single	575mm	650mm	970mm	470mm
LVA4S*HRP***** *****	Two Tone	575mm	650mm	970mm	470mm





Valido lounge chair with polished aluminium raised 4 star base and swivel mechanism. With & Without Headrest (HR).

No arms.

					
	FABRIC	WIDTH	DEPTH	HEIGHT	SEAT HEIGHT
LVAKY0P*****	Single	575mm	650mm	755mm	470mm
LVAKY*P***** *****	Two Tone	575mm	650mm	755mm	470mm
LVAKY0HRP*****	Single	575mm	650mm	970mm	470mm
LVAKY*HRP***** *****	Two Tone	575mm	650mm	970mm	470mm

Valido lounge chair with raised 4 leg wood base. With & Without Headrest (HR).

No arms.

					
	FABRIC	WIDTH	DEPTH	HEIGHT	SEAT HEIGHT
LVARW0 * *****	Single	590mm	600mm	755mm	470mm
LVARW* * ***** *****	Two Tone	590mm	600mm	755mm	470mm
LVARW0HR * *****	Single	590mm	660mm	970mm	470mm
LVARW*HR * ***** *****	Two Tone	590mm	660mm	970mm	470mm

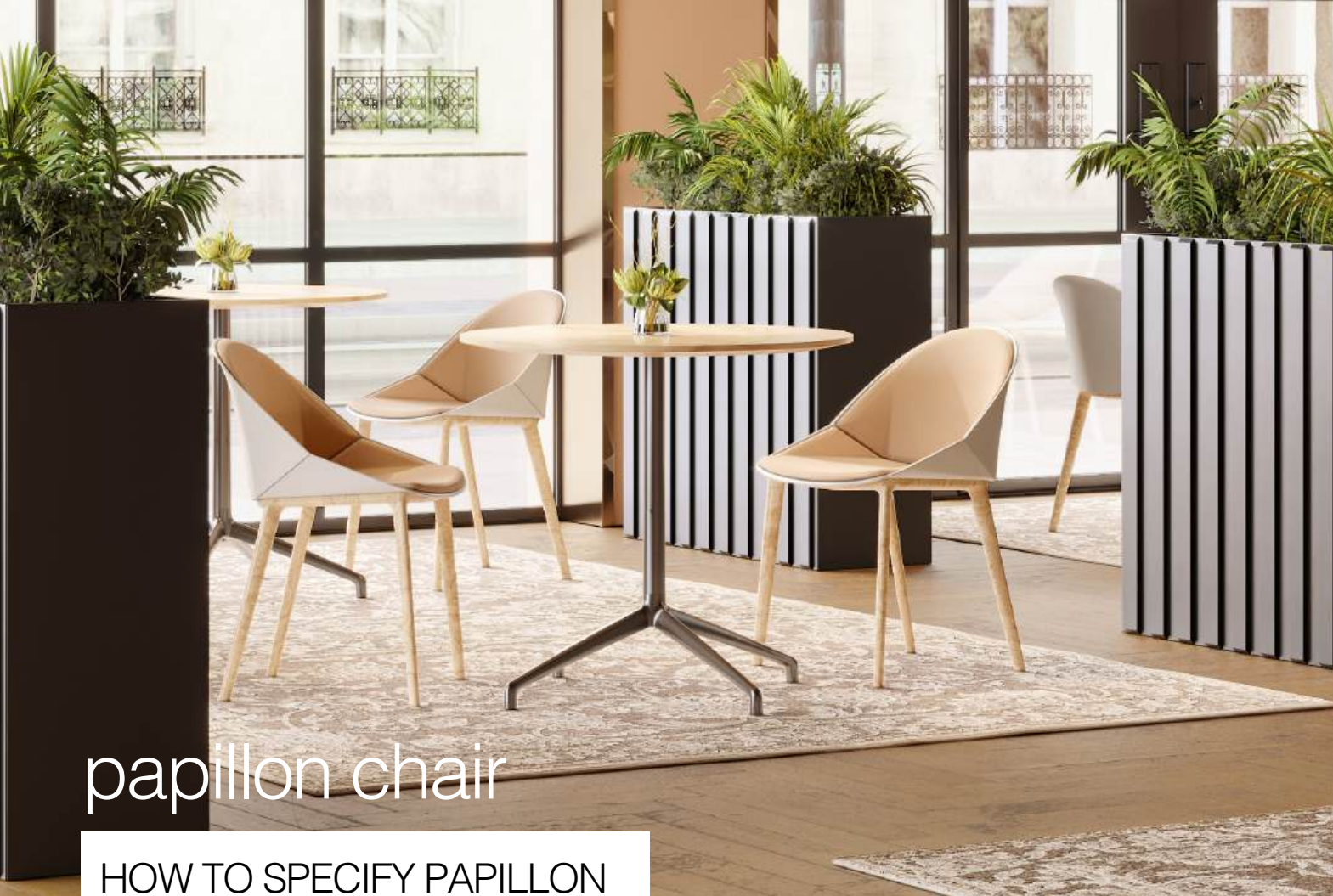

# papillon chair

## HOW TO SPECIFY PAPILLON



CODE  
(E.G: 'PA')

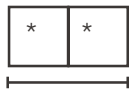

SHELL TYPE  
(E.G: 'IU')

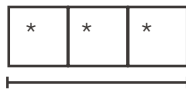

FRAME  
(E.G: '4WP')



FRAME  
( 'O')

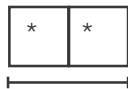

SHELL COLOUR  
(E.G: 'WH')

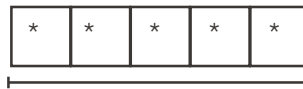

SEAT FABRIC COLOUR  
(EG: 'DEC08')

For example, to specify a Papillon Chair with 4 wood plastic legs and inside fabric Camira Deca Decadent DEC08 fabric, the code would be PAIU4WPOWHDEC08.

### Shell Colours

White	WH
Black	BK
Green	GR
Pink	PP
Cream	CM
Turquoise	TU

### Plastic Leg Colours

Black	B
Green	G
Pink	P
Cream	C
Turquoise	T

### Skid Base Colours

Black	B
-------	---

### Raised Base Colours

Black	B
White	W

### Fabric Colours

Fabric Band 1-5 & Leather.  
Colour code as per fabric  
manufacturers code. See the  
back of the brochure for full  
fabric band guide.

### 100% Recycled Shell Colours

Dark Red	DRR
Khaki Green	KGR

### 100% Recycled Plastic Leg

Black	BR
-------	----

### Wood Effect Plastic Leg

Oak Effect	O
------------	---

### Wood Leg

Ash with Black Cap	O
--------------------	---

### Base Options

4 Plastic Legs	4P
4 Wood Plastic Legs	4WP
4 Wood Legs	4W
Skid Base	SK
Raised Base with Castors	KYC
Raised Base	KY

# papillon

## Papillon Chair with Plastic 4 Leg Frame

Plastic shell & 100% Recycled Plastic Shell (PP), Plastic Shell with Seat Pad (SE) Plastic Shell with Inside Upholstery (IU) or Fully Upholstered (UP).



	SHELL/UPHOLSTERY	WIDTH	DEPTH	HEIGHT
PAPP4P * **	Shell	510mm	555mm	780mm
PAPP4P BR ***	100% Recycled Shell	510mm	555mm	780mm
PASE4P * ** *****	Shell with Seat Pad	510mm	555mm	780mm
PAIU4P * ** *****	Shell/ Inside Upholstery	510mm	555mm	780mm
PAUP4P * *****	Full Upholstery	510mm	555mm	780mm



## Papillon Chair with Plastic Wood Effect 4 Leg Frame

Plastic Shell (PP), Plastic Shell with Seat Pad (SE), Plastic Shell with Inside Upholstery (IU) or Fully Upholstered (UP).  
Oak Effect Plasticwood Legs.



	SHELL/UPHOLSTERY	WIDTH	DEPTH	HEIGHT
PAPP4WP O **	Shell Only	510mm	555mm	780mm
PASE4WP O ** *****	Shell with Seat Pad	510mm	555mm	780mm
PAIU4WP O ** *****	Shell/ Inside Upholstery	510mm	555mm	780mm
PAUP4WP O *****	Full Upholstery	510mm	555mm	780mm



## Papillon Chair with Wooden 4 Leg Frame

Plastic Shell (PP), Plastic Shell with Seat Pad (SE), Plastic Shell with Inside Upholstery (IU) or Fully Upholstered (UP).  
Ash wood legs and black outer seat.



	SHELL/UPHOLSTERY	WIDTH	DEPTH	HEIGHT
PAPP4W O **	Shell Only	510mm	555mm	785mm
PASE4W O ** *****	Shell with Seat Pad	510mm	555mm	785mm
PAIU4W O ** *****	Shell/ Inside Upholstery	510mm	555mm	785mm
PAUP4W O *****	Full Upholstery	510mm	555mm	785mm



## Papillon Chair with Black Skid Base.

Plastic Shell (PP), Plastic Shell with Seat Pad (SE), Plastic Shell with Inside Upholstery (IU) or Fully Upholstered (UP).

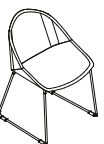





	SHELL/UPHOLSTERY	WIDTH	DEPTH	HEIGHT
PAPPSK B **	Shell Only	560mm	555mm	790mm
PASESK B ** *****	Shell with Seat Pad	560mm	555mm	790mm
PAIUSK B ** *****	Shell/ Inside Upholstery	560mm	555mm	790mm
PAUPSK B *****	Full Upholstery	560mm	555mm	790mm







**Papillon Chair with Raised Base.**

Plastic Shell (PP), Plastic Shell with Seat Pad (SE), Plastic Shell with Inside Upholstery (IU) or Fully Upholstered (UP). Black or White Base.

					
	SHELL/UPHOLSTERY	WIDTH	DEPTH	HEIGHT	
PAPPKY * **	Shell Only	700mm	700mm	760mm	
PASEKY * ** *****	Shell with Seat Pad	700mm	700mm	760mm	
PAIUKY * ** *****	Shell/ Inside Upholstery	700mm	700mm	760mm	
PAUPKY * *****	Full Upholstery	700mm	700mm	760mm	

**Papillon Chair with Raised Base with Castors.**

Plastic Shell (PP), Plastic Shell with Seat Pad (SE), Plastic Shell with Inside Upholstery (IU) or Fully Upholstered (UP). Black or White Base. Black castors.

					
	SHELL/UPHOLSTERY	WIDTH	DEPTH	HEIGHT	
PAPPKYC * **	Shell Only	700mm	700mm	760mm	
PASEKYC * ** *****	Shell with Seat Pad	700mm	700mm	760mm	
PAIUKYC * ** *****	Shell/ Inside Upholstery	700mm	700mm	760mm	
PAUPKYC * *****	Full Upholstery	700mm	700mm	760mm	







# olé chair

## HOW TO SPECIFY OLÉ



TOP CODE  
(E.G: 'OLPB')



UPH SEAT PAD BASE  
(E.G: 'SE')



BASE  
(E.G: 'SK')



BASE FINISH  
(E.G: 'C')



PLASTIC FINISH  
(E.G: 'MU')



FABRIC COLOUR  
(EG: 'CUZ2Q')

For example, to specify a Olé mono-shell chair with skid chrome frame, mustard shell the code would be OLPBSKCKMU.

### Base Finish

Chrome	C
Graphite	G
Polished	P

### Plastic Finishes

Dark Grey	DG
White	WH
Cream	CM
Mustard	MU

### Fabric Colours

Fabric Band 1-5 & Leather.  
Colour code as per fabric  
manufacturers code. See the  
back of the brochure for full  
fabric band guide.

# olé chair

## Olé mono-shell chair. Chrome 4 leg frame.

Mono-shell with optional upholstered seatpad. Graphite (G) or chrome (C) leg frame.

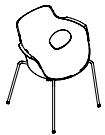
	FABRIC	WIDTH	DEPTH	HEIGHT	SEAT HEIGHT
					
OLPB4L* **	Non	590mm	575mm	790mm	460mm
OLPBSE4L* ** *****	Uph. Seat	590mm	575mm	790mm	470mm

## Olé mono-shell chair. Polished aluminium flat 4 star base with swivel.

Mono-shell with optional upholstered seatpad.

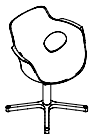
	FABRIC	WIDTH	DEPTH	HEIGHT	SEAT HEIGHT
					
OLPB4SP **	Non	590mm	535mm	755mm	435mm
OLPBSE4SP ** *****	Uph. Seat	590mm	535mm	755mm	445mm

## Olé mono-shell chair. Chrome rod skid frame.

Mono-shell with optional upholstered seatpad. Graphite (G) or chrome (C) leg frame.

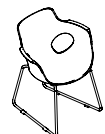
	FABRIC	WIDTH	DEPTH	HEIGHT	SEAT HEIGHT
					
OLPBSK* **	Non	590mm	565mm	785mm	455mm
OLPBSESK* ** *****	Uph. Seat	590mm	565mm	785mm	465mm

## Olé mono-shell chair. Polished aluminium 5 star base with castors.

Mono-shell with optional upholstered seatpad.

	FABRIC	WIDTH	DEPTH	HEIGHT	SEAT HEIGHT
					
OLPB5SP **	Non	697mm	663mm	770mm	455mm
OLPBSE5SP ** *****	Uph. Seat	697mm	663mm	770mm	465mm

## Additional upholstered seat pad for retrofitting with Velcro.

	FABRIC	WIDTH	DEPTH	HEIGHT	SEAT HEIGHT
					
OLSEAT *****	N/A	346mm	368mm	10mm	N/A



# olé wood chair

## HOW TO SPECIFY OLÉ WOOD



TOP CODE  
(E.G: 'OLWB')



UPH SEAT PAD  
(E.G: 'SE')

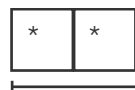

BASE  
(E.G: 'KY')



BASE FINISH  
(E.G: 'C')

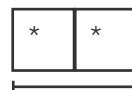

WOOD FINISH  
(E.G: 'NA')



FABRIC COLOUR  
(For example: 'CPC08')

For example, to specify an Olé Wood chair with polished aluminium raised 4 star base, natural wooden shell and an upholstered seat pad in Camira Gravity Evergreen CPC08 fabric, the code would be OLWBSEKYCNACPC08.

### Base Finish

Chrome	C
Graphite	G
Polished	P

### Fabric Colours

Fabric Band 1-5 & Leather.  
Colour code as per fabric manufacturers code. See the back of the brochure for full fabric band guide.

### Wood Finishes

White Oak	WO
Natural	NA
Wenge	WE

# olé wood chair

## Olé wooden shell chair. Chrome 4 leg frame.

Wooden shell with optional upholstered seatpad. Chrome (C) or Graphite (G) frame.

	FABRIC	WIDTH	DEPTH	HEIGHT	SEAT HEIGHT
					
OLWB4L * **	Non	555mm	575mm	800mm	455mm
OLWBSE4L * ** *****	Uph. Seat	555mm	575mm	800mm	465mm

## Olé wooden shell chair. Chrome rod skid frame.

Wooden shell with optional upholstered seatpad. Chrome (C) or Graphite (G) frame.

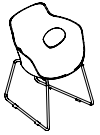
	FABRIC	WIDTH	DEPTH	HEIGHT	SEAT HEIGHT
					
OLWBSK * **	Non	555mm	565mm	795mm	450mm
OLWBSESK * ** *****	Uph. Seat	555mm	565mm	795mm	460mm

## Olé wooden shell chair. Polished aluminium raised 4 star base.

Wooden shell with optional upholstered seatpad.

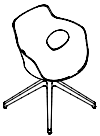
	FABRIC	WIDTH	DEPTH	HEIGHT	SEAT HEIGHT
					
OLWBKYP **	Non	555mm	540mm	775mm	455mm
OLWBSEKYP * ** *****	Uph. Seat	555mm	540mm	775mm	465mm

## Olé wooden shell chair. Polished aluminium flat 4 star swivel base.

Wooden shell with optional upholstered seatpad.

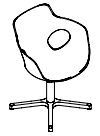
	FABRIC	WIDTH	DEPTH	HEIGHT	SEAT HEIGHT
					
OLWB4SP **	Non	555mm	535mm	755mm	455mm
OLWBSE4SP * ** *****	Uph. Seat	555mm	535mm	755mm	465mm

## Olé wooden shell chair. Polished aluminium 5 star base with castors.

Wooden shell with optional upholstered seatpad.

	FABRIC	WIDTH	DEPTH	HEIGHT	SEAT HEIGHT
					
OLWB5SP **	Non	697mm	663mm	768mm	455mm
OLWBSE5SP * ** *****	Uph. Seat	697mm	663mm	768mm	465mm

## Additional upholstered seat pad for retrofitting with Velcro.

	FABRIC	WIDTH	DEPTH	HEIGHT	SEAT HEIGHT
					
OLSEAT *****	N/A	346mm	368mm	10mm	N/A



# cyla chair

## HOW TO SPECIFY CYLA

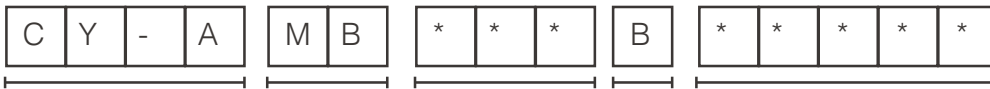

CODE (E.G: 'CY-A')      BACK (E.G: 'MB')      FRAME (E.G: '5ST')      FRAME ('B')      SEAT FABRIC COLOUR (EG: 'EJ105')

For example, to specify a Cyla 5 star base with Camira Cara Dolphin EJ105 fabric, the code would be CY-AMB5STBEJ105.

<b>Mesh</b> Black only	N/a	<b>Frame</b> Black	B	<b>Base Options</b> Cantilever Frame Raised Base with Castors 5 Star Base with Tilt Mechanism	CA KYC 5ST	<b>Fabric Colours</b> Fabric Band 1-5 & Leather. Colour code as per fabric manufacturers code. See the back of the brochure for full fabric band guide.
---------------------------	-----	-----------------------	---	--------------------------------------------------------------------------------------------------------	------------------	---------------------------------------------------------------------------------------------------------------------------------------------------------------

# cyla

## Cyla Meeting Chair with Cantilever Frame

With mesh back, integral arms & upholstered seat.



WIDTH



DEPTH



HEIGHT

CY-AMBCA B \*\*\*\*\*

605mm

600mm

915mm

## Cyla Meeting Chair with 5-star Frame, Castors & Tilt Mechanism

With mesh back, integral arms & upholstered seat.



WIDTH



DEPTH



HEIGHT

CY-AMB5ST B \*\*\*\*\*

605mm

700mm

920- 1000mm

## Cyla Meeting Chair with Raised Frame & Castors

With mesh back, integral arms & upholstered seat.



WIDTH



DEPTH



HEIGHT

CY-AMBKYC B \*\*\*\*\*

605mm

700mm

920 - 1000mm



# flexi-work chair

## HOW TO SPECIFY FLEXI-WORK



TOP CODE  
(E.G: 'FWPBSE')

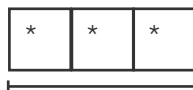

BASE  
(E.G: 'CA')



BASE FINISH  
(E.G: 'C')

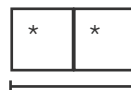

PLASTIC FINISH  
(E.G: 'WH')



FABRIC COLOUR  
(For example: 'OOC02')

For example, to specify a Flexi-Work chair with a chrome cantilever frame, white shell and Camira Oceanic Jetsam OOC02 fabric the code would be FWPBSECACWHOOC02.

### Base Finish

Chrome	C
Black (Raised Base Only)	B
Polished	P

### Plastic Finishes

Black	BK
Grey	GY
White	WH
Turquoise	TU

### Base Options

Cantilever Frame	CA
4 Leg Frame	4L
Raised Base	KY
5 Star Base	5S
5 Star Base with Tilt Mechanism	5ST
Stool	ST

### Fabric Colours





Fabric Band 1-5 & Leather.
Colour code as per fabric manufacturers code. See the back of the brochure for full fabric band guide.



# flexi-work





## Flexi-Work Chair with Chrome Cantilever Frame.

Perforated plastic back, integrated arms and upholstered seat. Chrome frame.

					
	FABRIC	WIDTH	DEPTH	HEIGHT	SEAT HEIGHT
FWPBSECA C ** *****	Uph. Seat	615mm	530mm	860mm	475mm





## Flexi-Work Chair with Raised Base & 360-Degree Swivel.

Perforated plastic back, integrated arms and upholstered seat. Polished (P) or Black (B) frame.

					
	FABRIC	WIDTH	DEPTH	HEIGHT	SEAT HEIGHT
FWPBSEKY * ** *****	Uph. Seat	615mm	520mm	860mm	475mm





## Flexi-Work Chair with Polished Aluminium 5 Star Base, Without & With Tilt (T)

Perforated plastic back, integrated arms & uph seat.

					
	FABRIC	WIDTH	DEPTH	HEIGHT	SEAT HEIGHT
FWPBSE5S P ** *****	Uph. Seat	640mm	640mm	835/915	460/540
FWPBSE5ST P ** *****	Uph. Seat	640mm	640mm	835/915	460/540





## Flexi-Work Chair with Chrome 4 Leg Frame.

Perforated plastic back, integrated arms and upholstered seat. Chrome frame.

					
	FABRIC	WIDTH	DEPTH	HEIGHT	SEAT HEIGHT
FWPBSE4L * ** *****	Uph. Seat	615mm	555mm	860mm	475mm

## Flexi-Work Stool with Black Draughtsman Base & Matching Footring.

Perforated plastic back, integrated arms and upholstered seat.

					
	FABRIC	WIDTH	DEPTH	HEIGHT	SEAT HEIGHT
FWTSTSE B ** *****	Uph. Seat	640mm	640mm	1085/1335	680/930



# tonez chair

## HOW TO SPECIFY TONEZ

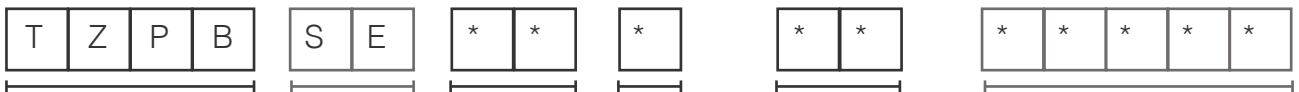

TOP CODE  
(E.G: 'TZPB')

SEAT PAD  
(E.G: 'SE')

FRAME  
(E.G: 'SK')

BASE FINISH  
(E.G: 'W')

PLASTIC FINISH  
(E.G: 'WH')

FABRIC COLOUR  
(E.G: 'CUZ1R')

For example, to specify a Tonez chair with skid base finished in a white seat and frame with Camira Blazer Plymouth CUZ1R fabric the code would be TZPBSESKWWHCUZ1R.

### Base Finish

Polished (5 Star Only)	P
4 Leg & Skid Only	
White	W
Peach Pink	E
Dark Grey	D
Green	G

### Plastic Finishes

White	WH
Peach Pink	PP
Dark Grey	DG
Green	GN

### Frame Options

4 Leg Frame	4L
Skid Base	SK
5 Star Base	5S

### Fabric Colours

Fabric Band 1-5 & Leather.  
Colour code as per fabric manufacturers code. See the back of the brochure for full fabric band guide.

# tonez chair

## Tonez chair with 4 painted legs.

Painted base. Stacks 4 high freestanding.



	FABRIC	WIDTH	DEPTH	HEIGHT	SEAT HEIGHT
TZPB4L * **	Non	565mm	555mm	785mm	450mm
TZPBSE4L * ** *****	Uph. Seat	565mm	555mm	785mm	475mm



## Tonez chair with painted skid base.

Painted base. Stacks 4 high freestanding.

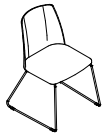

	FABRIC	WIDTH	DEPTH	HEIGHT	SEAT HEIGHT
TZPBSK * **	Non	565mm	555mm	785mm	450mm
TZPBSESK * ** *****	Uph. Seat	565mm	555mm	785mm	475mm



## Tonez chair with polished aluminium 5 star base.

Polished aluminium base with or without an upholstered seat.



	FABRIC	WIDTH	DEPTH	HEIGHT	SEAT HEIGHT
TZPB5SP **	Non	640mm	535mm	730/855	385/510
TZPBSE5SP * ** *****	Uph. Seat	640mm	535mm	730/855	400/535



## Tonez stacking trolley to stack up to 6 chairs.

TZ/T.

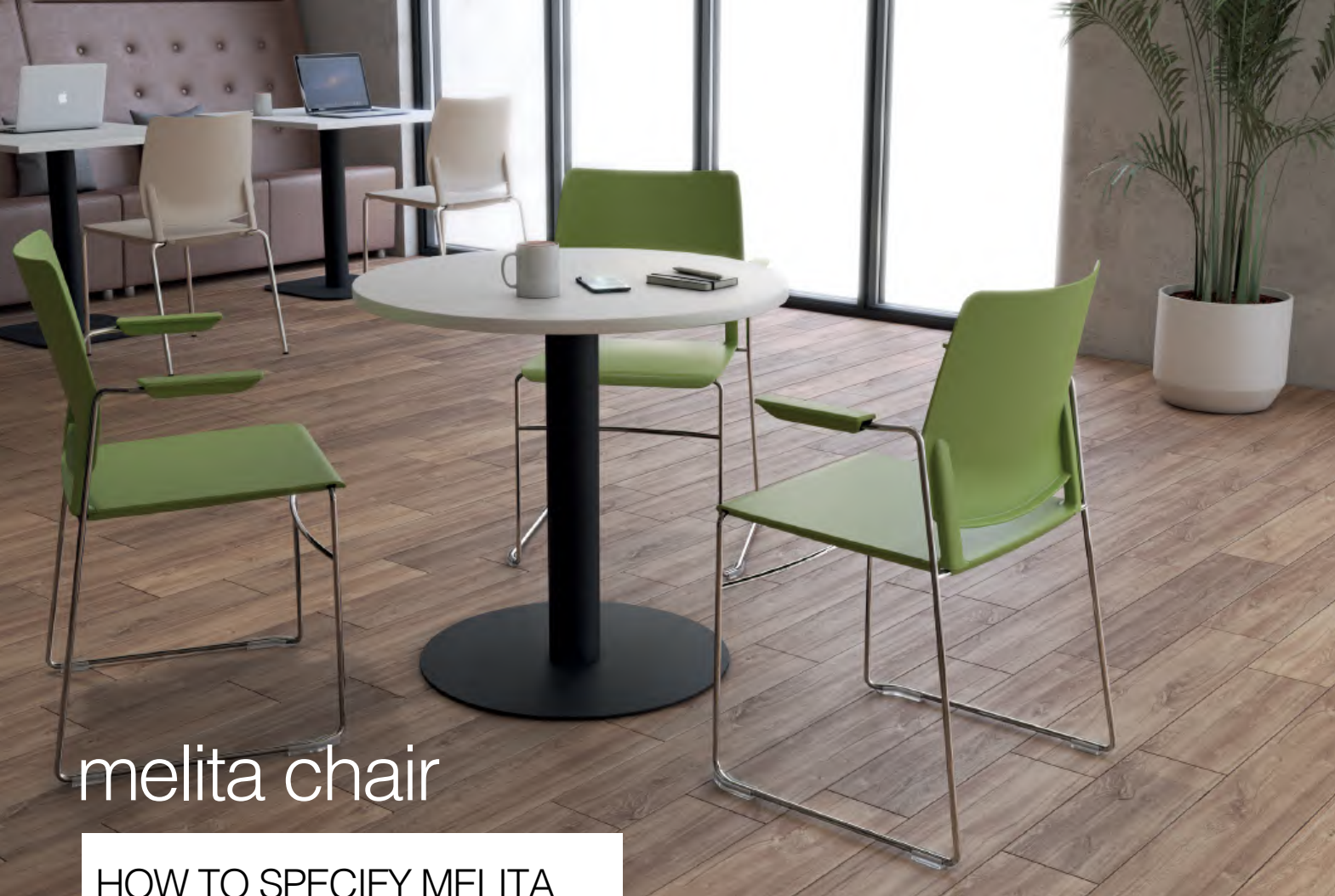

# melita chair

## HOW TO SPECIFY MELITA

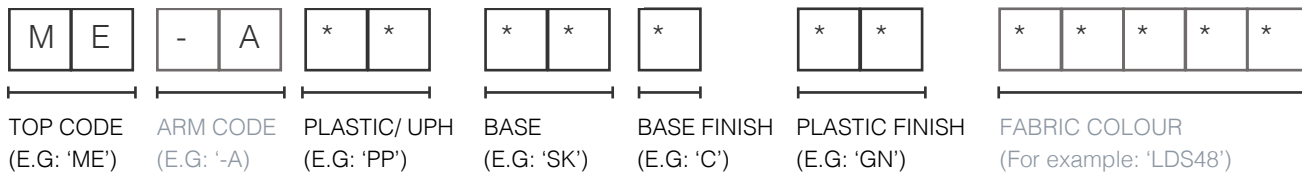

For example, to specify a Melita chair with skid chrome frame and arms in green plastic back and seat the code would be ME-APPSKCGN.

### Plastic Back or Upholstered

Plastic Back and Seat	PP
Plastic Back and Upholstered Seat	PU

### Arms

Plastic arms	-A
Foldable laptop tablet	
Right Handed	-RT
Left Handed	-LT

*For no arms, leave '-A' out of the code*

### Base Finish

Chrome	C
Black (non arm chairs only)	B

### Plastic Finishes

Black	BK
Grey	GY
White	WH
Cream	CM
Green	GN
Dark Red	DR
Dark Blue	DB





### Fabric Colours

C Fabric Band 1-5 & Leather.  
B Colour code as per fabric manufacturers code. See the back of the brochure for full fabric band guide.

# melita chair





Melita chair with solid plastic back. 4 leg frame. With optional Arms '-A' or right or left handed tablet '-\*T'

Plastic seat & back or plastic back and upholstered seat. Chrome (C) frame, or black (B) frame - non arm chairs only.

							
	FABRIC	ARM/ TABLET	WIDTH	DEPTH	HEIGHT	SEAT HEIGHT	
MEPP4L * **	Non	N/a	500mm	530mm	855mm	460mm	
MEPU4L * ** *****	Uph. Seat	N/a	500mm	530mm	855mm	490mm	
ME-APP4LC**	Non	Arms	580mm	530mm	855mm	460mm	
ME-APU4LC** *****	Uph. Seat	Arms	580mm	530mm	855mm	490mm	
ME-*TPP4LC**	Non	Tablet	615mm	690mm	855mm	460mm	
ME-*TPU4LC** *****	Uph. Seat	Tablet	615mm	690mm	855mm	490mm	

Melita chair with solid plastic back. Skid frame. With optional Arms '-A' or right or left handed tablet '-\*T'

No arms, plastic seat & back or plastic back and upholstered seat. Chrome (C) frame, or black (B) frame - non arm chairs only.

							
	FABRIC	ARM/ TABLET	WIDTH	DEPTH	HEIGHT	SEAT HEIGHT	
MEPPSK * **	Non	N/a	535mm	505mm	855mm	460mm	
MEPUSK * ** *****	Uph. Seat	N/a	535mm	505mm	855mm	490mm	
ME-APPSKC**	Non	Arms	585mm	505mm	855mm	460mm	
ME-APUSKC** *****	Uph. Seat	Arms	585mm	505mm	855mm	490mm	
ME-*TPPSKC**	Non	Tablet	615mm	665mm	855mm	460mm	
ME-*TPUSKC** *****	Uph. Seat	Tablet	615mm	665mm	855mm	490mm	

## Additional Items





Melita linking glides left and right.  
ZLINKG.

Melita stacking trolley to stack up to 20 chairs.  
ME/T

# melita stool

Melita stool with solid plastic back. Chrome 4 leg frame with footrest.

Plastic seat and back or plastic back and upholstered seat.

							
	FABRIC	ARM/ TABLET	WIDTH	DEPTH	HEIGHT	SEAT HEIGHT	
MESTPP4LC**	Non	N/a	540mm	550mm	1150mm	750mm	
MESTPU4LC** *****	Uph. Seat	N/a	540mm	550mm	1150mm	750mm	

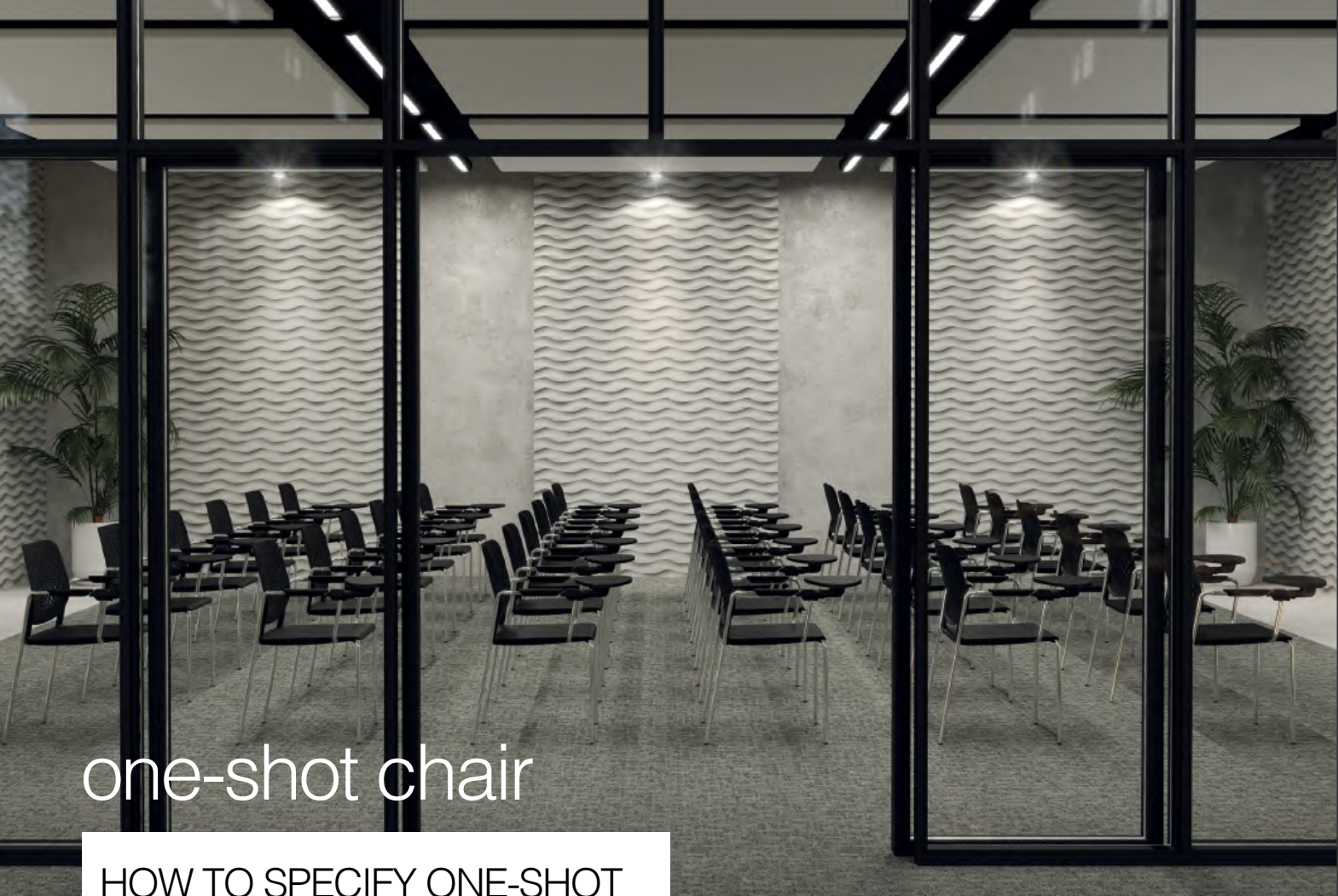

# one-shot chair

## HOW TO SPECIFY ONE-SHOT

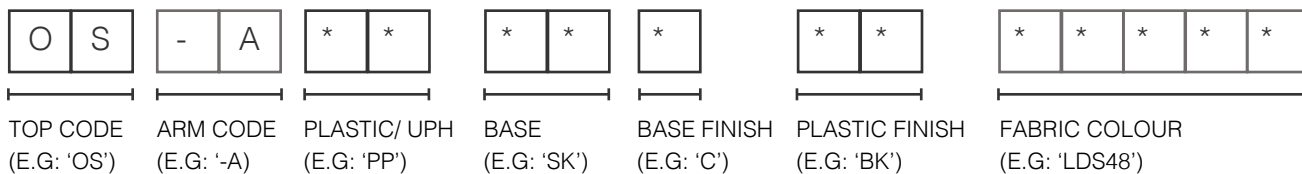

For example, to specify a One-Shot chair with skid chrome frame with arms in black plastic back and seat the code would be OSPPSKCBK.

### Plastic Back or Upholstered

Plastic Back and Seat	PP
Plastic Back and Upholstered Seat	PU

### Arms

Plastic arms	-A
Foldable laptop tablet	
Right Handed	-RT
Left Handed	-LT

### Base Finish

Chrome	C
Black (non arm chairs only)	B

### Fabric Colours

C Fabric Band 1-5 & Leather.  
 B Colour code as per fabric manufacturers code. See the back of the brochure for full fabric band guide.

### Bases

4 Legs	4L
Skid Base	SK
Stool	ST





*For no arms, leave '-A' out of the code*

### Plastic Finishes





Black	BK
White	WH
Cream	CM
Dark Red	DR
Dark Blue	DB

# one-shot chair

One-Shot chair with perforated plastic back. Chrome 4 leg frame. With optional Arms '-A' or right or left handed tablet '-\*T'  
Plastic back with plastic / upholstered seat. Chrome (C) frame, or black (B) frame - non arm chairs only.

						
	FABRIC	ARMS/ TABLET	WIDTH	DEPTH	HEIGHT	SEAT HEIGHT
OSPP4L * **	Non	None	500mm	530mm	845mm	460mm
OSPU4L * ** *****	Uph. Seat	None	500mm	530mm	845mm	490mm
OS-APP4LC**	Non	Arms	580mm	530mm	845mm	460mm
OS-APU4LC ** *****	Uph. Seat	Arms	580mm	530mm	845mm	490mm
OS-*TPP4LC **	Non	Tablet	600mm	690mm	845mm	460mm
OS-*TPU4LC ** *****	Uph. Seat	Tablet	600mm	690mm	845mm	490mm

One-Shot chair with perforated plastic back. Chrome rod skid frame. With optional Arms '-A' or right or left handed tablet '-\*T'  
Plastic back with plastic / upholstered seat. Chrome (C) frame, or black (B) frame - non arm chairs only.

						
	FABRIC	ARMS/ TABLET	WIDTH	DEPTH	HEIGHT	SEAT HEIGHT
OSPPSK * **	Non	None	535mm	505mm	845mm	460mm
OSPUK * ** *****	Uph. Seat	None	535mm	505mm	845mm	490mm
OS-APPSKC **	Non	Arms	580mm	505mm	845mm	460mm
OS-APUSKC ** *****	Uph. Seat	Arms	580mm	505mm	845mm	490mm
OS-*TPPSKC **	Non	Tablet	600mm	690mm	845mm	460mm
OS-*TPUSKC ** *****	Uph. Seat	Tablet	600mm	690mm	845mm	490mm





## Additional Items

One-Shot linking glides left and right.  
ZLINKG.

One-Shot stacking trolley to stack up to 20 chairs.  
OS/T

# one-shot stool

One-Shot stool with solid plastic back. Chrome 4 leg frame with footrest.  
Plastic back with plastic / upholstered seat.

						
	FABRIC	ARMS/ TABLET	WIDTH	DEPTH	HEIGHT	SEAT HEIGHT
OSSTPP4LC **	Non	None	540mm	550mm	1150mm	750mm
OSSTPU4LC ** *****	Uph. Seat	None	540mm	550mm	1150mm	780mm



# college chair

## HOW TO SPECIFY COLLEGE



TOP CODE  
(E.G: 'CLPB')



UPH SEAT PAD  
(E.G: 'SE')



PLASTIC FINISH  
(E.G: 'OR')



FABRIC COLOUR  
(For example: 'LDS48')

For example, to specify a College chair in orange shell the code would be CLPBOR.

### Plastic Finishes

Grey  
Yellow  
Orange  
Green  
Blue  
Red

GY  
YW  
OR  
GN  
BU  
RE

### Fabric Colours

Fabric Band 1-5 & Leather.  
Colour code as per fabric  
manufacturers code. See the  
back of the brochure for full  
fabric band guide.



# college chair

## College seminar mobile chair with solid plastic shell.

Universal handing orbital writing tablet/laptop table with integrated pen holder and under seat storage tray. Plastic shell with optional upholstered seat pad.

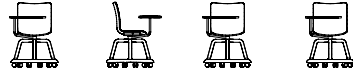

	FABRIC	WIDTH	DEPTH	HEIGHT	SEAT HEIGHT
CLPB**	Non	630mm	730mm	860mm	450mm
CLPBSE** *****	Uph. Seat	630mm	730mm	860mm	450mm

## College retrofitted seat pad with Velcro attachment.

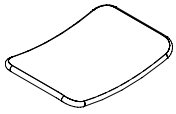

	FABRIC	WIDTH	DEPTH	HEIGHT	SEAT HEIGHT
CLSEAT *****	Uph. Seat	430mm	300mm	30mm	30mm



94 outdoor furniture





# nuke in/out stacking chair

## HOW TO SPECIFY NUKE

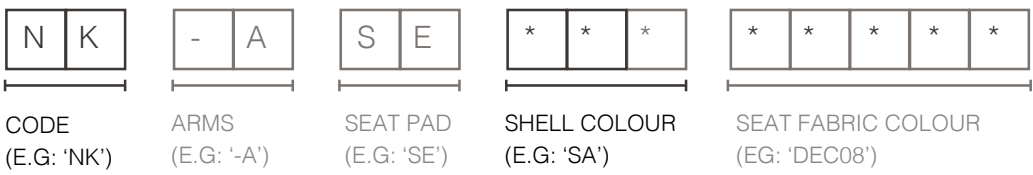

For example, to specify a pink Nuke chair with arms (pictured above), the code would be NK-APP.

### Chair Shell Colours

White	WH
Green	GR
Pink	PP
Sandy	SA
Light Blue	LB
Orange	OR
Red	RD

### 100% Recycled Shell Colours

Black	BKR
Light Grey	LGR
Dark Blue	DBR

### Stool Shell Colours

White	WH
Green	GR
Pink	PP
Light Blue	LB
Red	RD

### 100% Recycled Shell Colours

Black	BKR
Light Grey	LGR

### Fabric Colours

Fabric Band 1-5. Colour code as per fabric manufacturers code. See the back of the brochure for full fabric band guide.

Please note, fabric seat pads are for indoor use only.

### Chair Arms

No Arms	
Arms	-A

### Stool Heights

Low Stool	LST
High Stool	HST

# nuke

## Nuke Chair.

No arms. Seat height: 460mm.



SHELL/UPHOLSTERY	WIDTH	DEPTH	HEIGHT	
NK **	Shell	560mm	530mm	820mm
NK ***	100% Recycled Shell	560mm	530mm	820mm
NK SE** *****	Shell with Seat Pad	560mm	530mm	820mm

## Nuke Chair.

With arms. Seat height: 460mm.



SHELL/UPHOLSTERY	WIDTH	DEPTH	HEIGHT	
NK-A **	Shell	630mm	530mm	820mm
NK-A ***	100% Recycled Shell	630mm	530mm	820mm
NK-A SE ** *****	Shell with Seat Pad	630mm	530mm	820mm

## Nuke Low Stool.

No arms. Seat height: 670mm

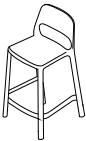

SHELL/UPHOLSTERY	WIDTH	DEPTH	HEIGHT	
NKLST **	Shell	490mm	490mm	915mm
NKLST ***	100% Recycled Shell	490mm	490mm	915mm
NKLST SE ** *****	Shell with Seat Pad	490mm	490mm	915mm

## Nuke High Stool.

No arms. Seat height: 770mm

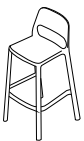

SHELL/UPHOLSTERY	WIDTH	DEPTH	HEIGHT	
NKHST **	Shell	495mm	505mm	1015mm
NKHST ***	100% Recycled Shell	495mm	505mm	1015mm
NKHST SE ** *****	Shell with Seat Pad	495mm	505mm	1015mm



# decorative screens

## HOW TO SPECIFY DECORATIVE SCREENS

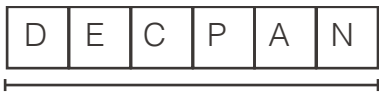

CODE  
(E.G: 'DECPAN' shown above)

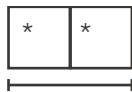

SIZE  
(E.G: '90')

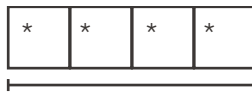

DESIGN  
(E.G: 'BEES')

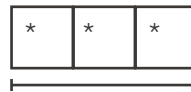

STEEL FINISH  
(E.G: 'BPQ')

For example, to specify a Honeycomb and Bee's 900mm wide panel in interior black paint, the code would be DECPAN90BEESBPQ

### Exterior Steel Finishes

Black (Quartz Texture)	BPQ
Corten/Copper (Quartz Texture)	CPQ
Asgard Grey (Leatherette Texture)	APT

# decorative screens

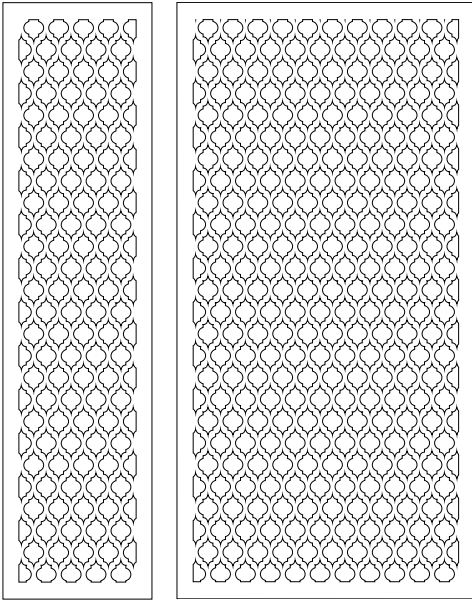

## Moroccan Decorative Screen

Wall mounted metal decorative screen/ trellis .

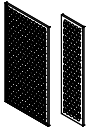

	WIDTH	DEPTH	HEIGHT
--	-------	-------	--------

DECPAN45MORO ***	450mm	28mm	1800mm
DECPAN90MORO ***	900mm	28mm	1800mm

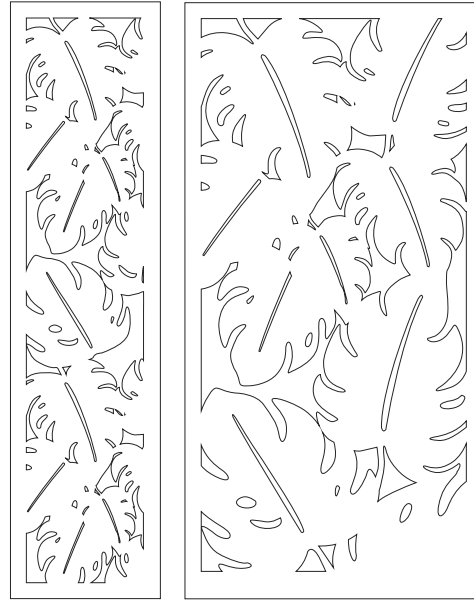

## Monstera Decorative Screen

Wall mounted metal decorative screen/ trellis .



	WIDTH	DEPTH	HEIGHT
--	-------	-------	--------

DECPAN45MONS**	450mm	28mm	1800mm
DECPAN90MONS ***	900mm	28mm	1800mm

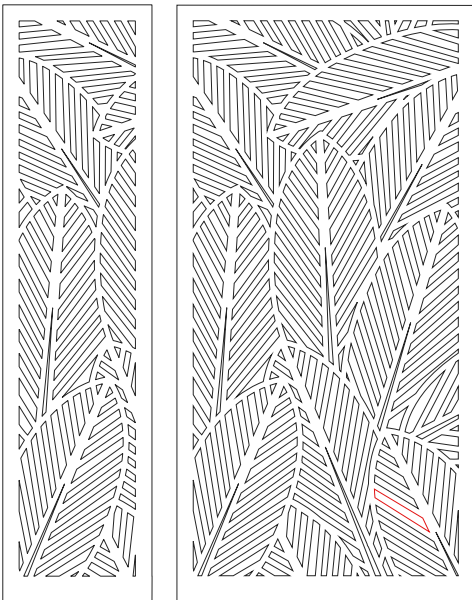

## Tropical Leaf Decorative Screen

Wall mounted metal decorative screen/ trellis .



	WIDTH	DEPTH	HEIGHT
--	-------	-------	--------

DECPAN45LEAF ***	450mm	28mm	1800mm
DECPAN90LEAF ***	900mm	28mm	1800mm

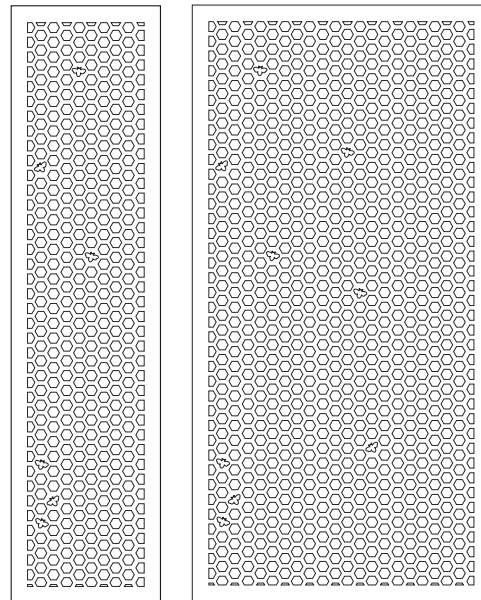

## Honeycomb & Bees Decorative Screen

Wall mounted metal decorative screen/ trellis .



	WIDTH	DEPTH	HEIGHT
--	-------	-------	--------

DECPAN45BEES ***	450mm	28mm	1800mm
DECPAN90BEES ***	900mm	28mm	1800mm



# flora & fauna

## HOW TO SPECIFY FLORA & FAUNA



CODE  
(E.G: 'PLANT' shown above)

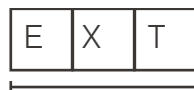

SUITABILITY  
(E.G: 'EXT')



WIDTH  
(E.G: '0900')

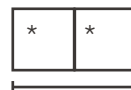

HEIGHT  
(E.G: '07')



STYLE  
(E.G: 'S')

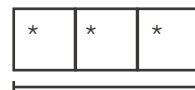

STEEL FINISH  
(E.G: 'BPQ')

For example, to specify a Fauna exterior slatted planter, 900mm wide x 350mm x 700mm to sit at the end of a back-to-back desk, in black (as above), the code would be PLANTEXT090007SBPQ.

Excludes compost, plants and horticultural advice. Counterbalance tray recommended to add a counterbalance weight. Please note, we do not recommend the Fauna slatted planters in light colour schemes due to the nature of the construction.

### Exterior Steel Finishes

Black (Quartz Texture)	BPQ
Corten/Copper (Quartz Texture)	CPQ
Asgard Grey (Leatherette Texture)	APT



# flora & fauna

## Flora External Plain Freestanding Planter

Includes internal shallow tray. Drainage holes. Includes Fixing Kit.

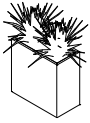

WIDTH



DEPTH\*



HEIGHT

PLANTEXT070003P ***	700mm	350mm	350mm
PLANTEXT070007P ***	700mm	350mm	700mm
PLANTEXT090003P ***	900mm	350mm	350mm
PLANTEXT090007P ***	900mm	350mm	700mm

## Fauna External Slatted Freestanding Planter

Includes internal shallow tray. Drainage holes. Includes Fixing Kit. Slats on 1 side.

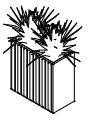

WIDTH



DEPTH\*



HEIGHT

PLANTEXT070003S ***	700mm	350mm	350mm
PLANTEXT070007S ***	700mm	350mm	700mm
PLANTEXT090003S ***	900mm	350mm	350mm
PLANTEXT090007S ***	900mm	350mm	700mm

## Counterbalance Weight Tray

PLANTBALBPQ



finishes

# steel

## STANDARD STEEL PAINT FINISHES, MATT FINISH

All our paints and paint processes are rigorously tested to ensure the highest quality paint quality including indentation test, cross cut & adhesion test and bend test. All paint is applied at a minimum thickness of 35 microns.

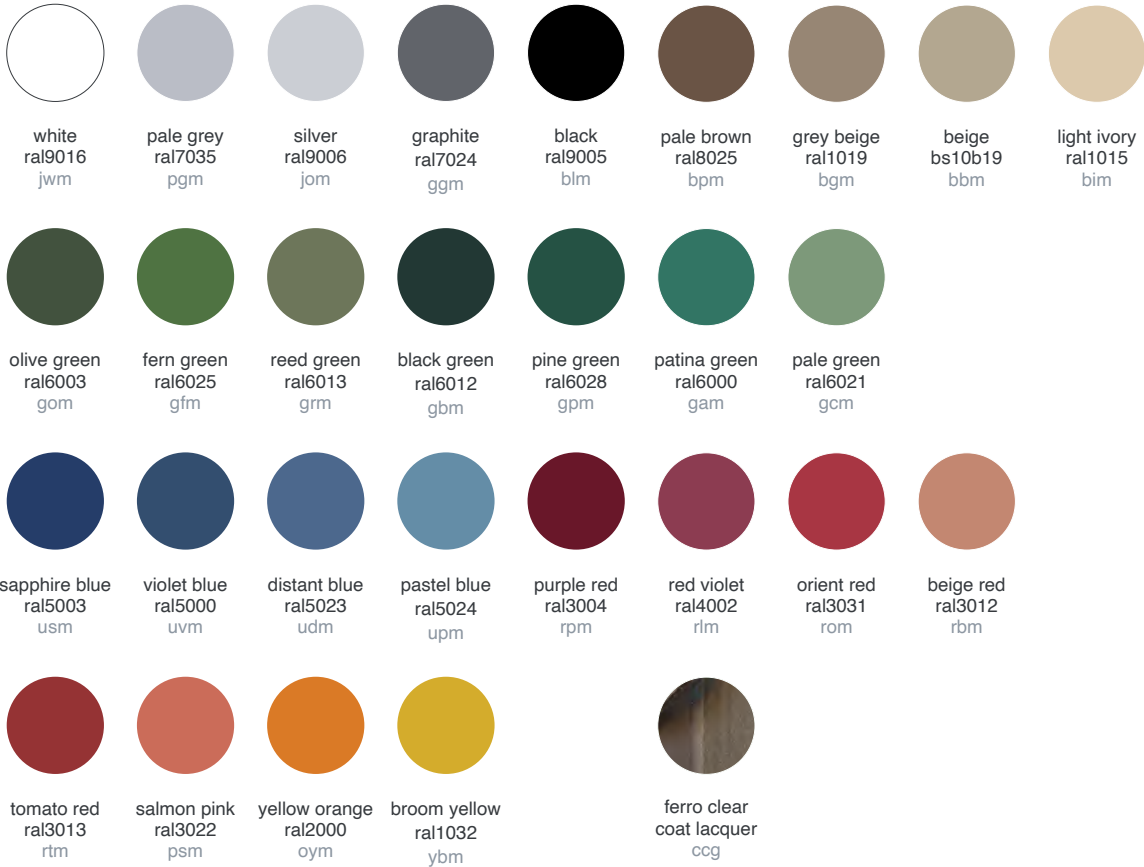

# tables

## ALTERNATIVE TABLE LEG FINISHES





# wood tops & doors

## MFC, BAND 1

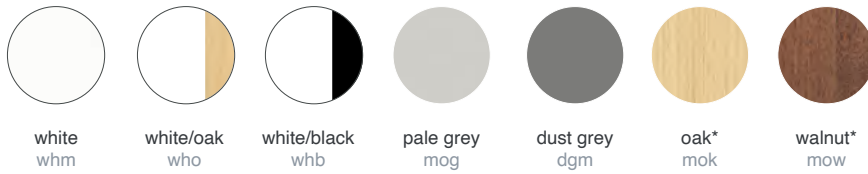

white whm   white/oak who   white/black whb   pale grey mog   dust grey dgm   oak\* mok   walnut\* mow

## MFC, BAND 2



sevilla ash msa   hamilton oak mho   nebraska oak mno   truffle brown denver oak mdo   natural carini walnut mcw   light grey chicago concrete mcc   cashmere grey msc   antique rose mar   reed green mrg   denim blue mdb

## LAMINATE, Band 1



white l02   pale grey l06   dust grey l23

## LAMINATE, BAND 2



sevilla ash l14   hamilton oak l15   nebraska oak l11   truffle brown denver oak l16   natural carini walnut l17   light grey chicago concrete l18   cashmere grey l19   antique rose l20   reed green l21   denim blue l22

## PERFECTSENSE SMOOTH LAMINATE WORKTOPS



black p06   cubanit grey p05   cashmere grey p04   indigo blue p03   garnet red p02   stone green p01

## FENIX PREMIUM LAMINATE WORKTOPS

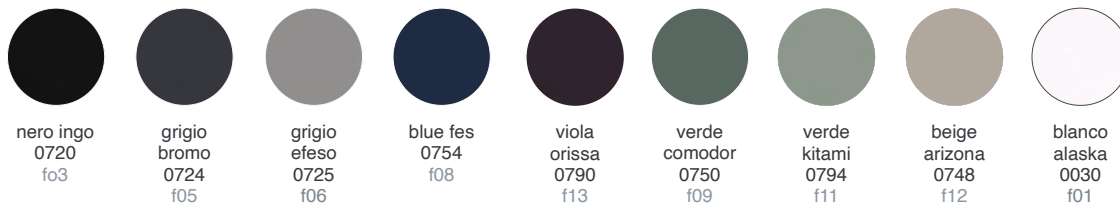

nero ingo 0720 fo3   grigio bromo 0724 f05   grigio efeso 0725 f06   blue fes 0754 f08   viola orissa 0790 f13   verde comodor 0750 f09   verde kitami 0794 f11   beige arizona 0748 f12   blanco alaska 0030 f01

# wood doors

## LUXO LOCKER BIOCARBON LAMINATE

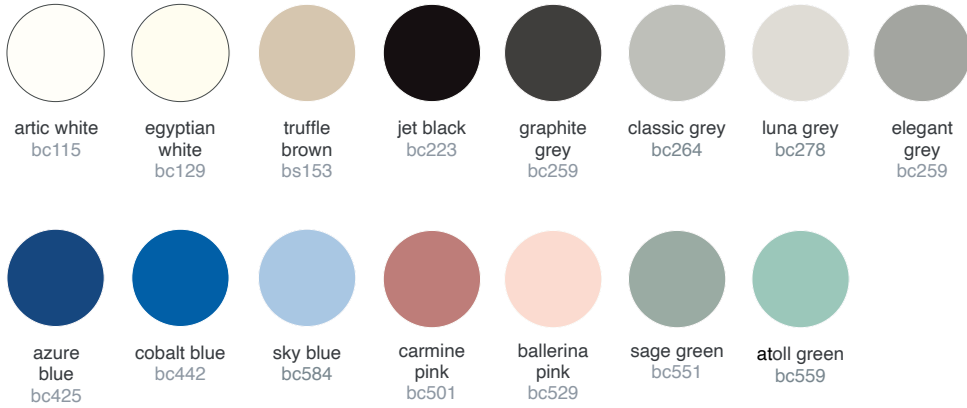

# tambour slats

## TAMBOUR FINISHES



# channel table accessories

## CHANNEL LIGHT FINISHES



## CHANNEL TABLE UPHOLSTERED CENTRE

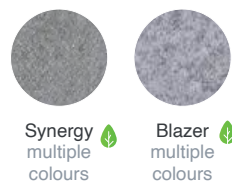

## CHANNEL ELECTRIC FINISHES

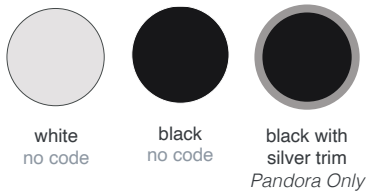

# flexigrid

MFC

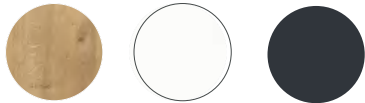

hamilton oak      white      graphite

STEEL



white      black      anthracite      reed green      clear coat lacquer

# hoop

MFC



white mfc      carbon grey mfc      black mfc      sorano oak mfc      hamilton oak mfc

STEEL



clear coat lacquer frame      salmon pink ral3022 frame      reed green ral6013 frame      pale green ral6021 frame      black ral9017 steel      silver ral9006 frame      white ral9016 steel

# screens

SOUND FINISHES

Click on the fabric circle to view the whole range online.

BAND1	 <p>Camira Era multiple colours</p>	 <p>Camira Lucia multiple colours</p>	BAND2	 <p>Camira Quest multiple colours</p>	BAND3	 <p>Camira Main Line Twist multiple colours</p>	 <p>Camira Main Line Flax multiple colours</p>	 <p>Camira Blazer multiple colours</p>	 <p>Camira Synergy multiple colours</p>
-------	----------------------------------------------------------------------------------------------------------------------------	------------------------------------------------------------------------------------------------------------------------------	-------	------------------------------------------------------------------------------------------------------------------------------	-------	----------------------------------------------------------------------------------------------------------------------------------------	---------------------------------------------------------------------------------------------------------------------------------------	--------------------------------------------------------------------------------------------------------------------------------	----------------------------------------------------------------------------------------------------------------------------------

Olé Mono-Shell Chair White/ Cream





# chair fabric

## SEATING FABRICS

Click on the fabric circle to view the whole range online.

BAND1										
BAND2										
BAND3										
BAND4										
BAND5										
LEATHER										

# chairs

## OLÉ MONO-SHELL CHAIR RANGE (SHELL/BASE)

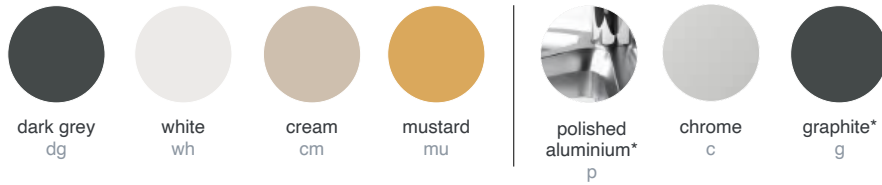

## ONE-SHOT CHAIR RANGE (SHELL/BASE)



## MELITA CHAIR RANGE (SHELL/BASE)

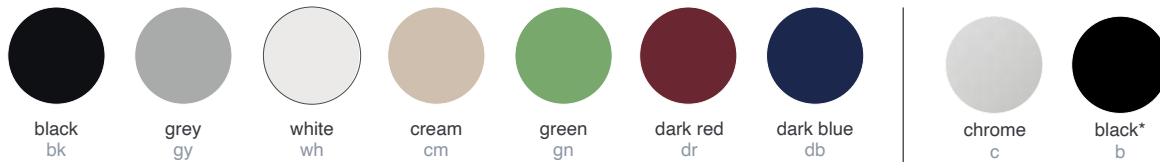

## COLLEGE CHAIR RANGE (SHELL/BASE)



## FLEXI-WORK CHAIR RANGE (SHELL/BASE)

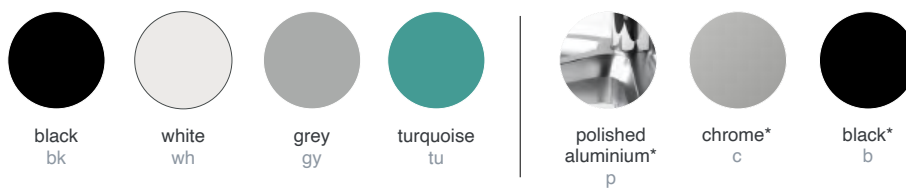

## TONEZ CHAIR RANGE (SHELL/BASE)

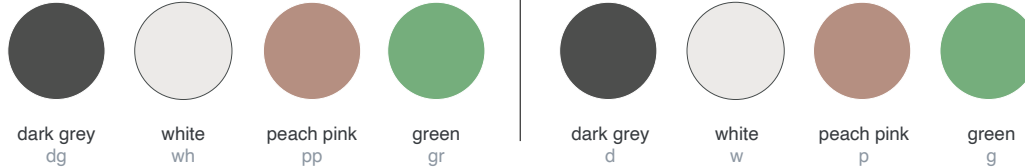

## NUKE CHAIR RANGE (SHELL)



PAPILLON (SHELL & PLASTIC BASES / ALTERNATIVE BASES)

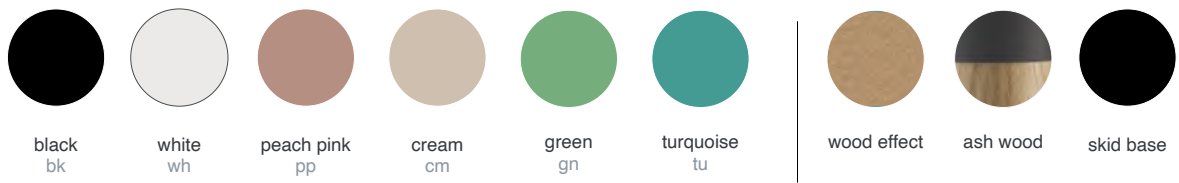

PAPILLON 100 % RECYCLED (SHELL/BASE)

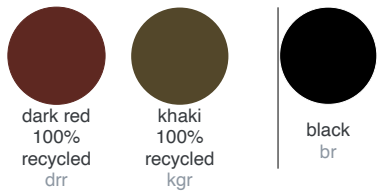

ACTUALIZE & EQUITY TASK CHAIR RANGE (MESH/ FRAME/ BASE)

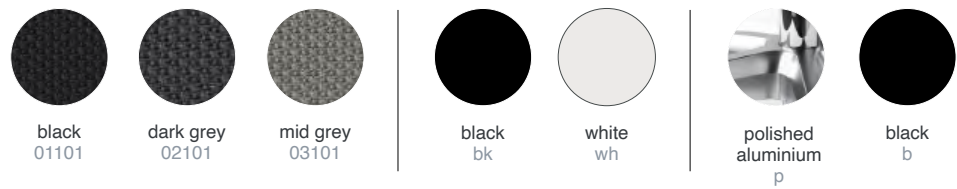

EQUITY MEETING CHAIR RANGE (MESH/ FRAME)

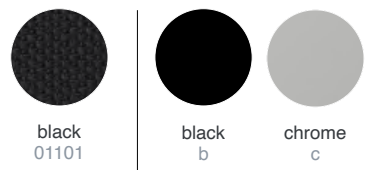

OLÉ WOOD CHAIR RANGE

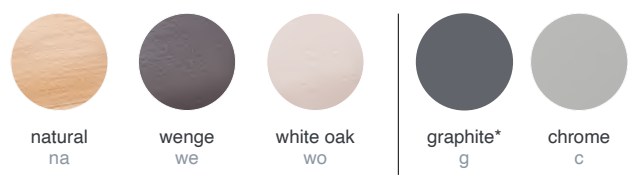

MISS/ VALIDO BASE



CYLA MEETING CHAIR RANGE (MESH/ FRAME)

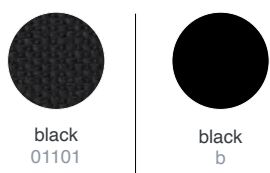



#### YORKSHIRE

Flexiform  
1392 Leeds Road  
Bradford  
West Yorkshire  
BD3 7AE

t: 01274 706206

#### LONDON HQ

Flexiform  
1st Floor  
45 Gee Street  
London  
EC1V 3RS

t: 02033 010436

#### SCOTLAND

Flexiform  
2B Young Square  
Brucefield Industry Park  
Bellsquarry, Livingston  
EH54 9BX

t: 01506 416410

Find us online:



Company Registration Number: 02542123

**flexiform**  
[www.flexiform.co.uk](http://www.flexiform.co.uk)